

DAY COLLECTION

# ART

TARIFA TÉCNICA

**Besform**

# ART



ART es un sistema de estanterías de gran posibilidad compositiva. Partimos de la unidad básica, un estante, este por si solo tiene su función. Podemos sumar unidades en sentido vertical u horizontal, también podemos intercalar módulos Mitra o intercalar estantes Art en composiciones Mitra para obtener la función y la forma que nos propongamos.

Formalmente, ART es un estante muy liviano que se presenta con tres terminaciones, frontal liso, "alistonado" o combinado. También cuenta con la opción de iluminación led perimetral.

ART nos permite, gracias a su componibilidad y simbiosis con el programa Mitra, resolver cualquier necesidad formal y funcional que se nos plantee en el plano vertical.

*ART is a shelving range with great compositional possibilities. We start from the basic unit, a shelf, which has its own function. We can add units vertically or horizontally, we can also insert Mitra modules or Art shelves in Mitra compositions to obtain the function and form we want.*

*Formally, ART is a very light shelf that comes in three finishes, smooth, "slatted" or combined front. It also has the option of perimeter LED lighting.*

*Thanks to its modularity and symbiosis with the Mitra range, ART allows us to solve any formal and functional need that arises in the vertical plane.*

## Estante liso



Hasta ancho 120 cm un separador, a partir de ancho 150 cm 2 separadores.  
Fondo total 28 cm.



Hasta ancho 120 cm un separador, a partir de ancho 150 cm 2 separadores.  
Fondo total 28 cm.

| Ancho      | Altura 25 cm |
|------------|--------------|
| Referencia |              |
| 45         | A-3300       |
| 60         | A-3301       |
| 75         | A-3302       |
| 90         | A-3303       |
| 120        | A-3304       |
| 150        | A-3305       |
| 180        | A-3306       |
| 210        | A-3307       |
| 240        | A-3308       |

| Ancho      | Altura 37 cm |
|------------|--------------|
| Referencia |              |
| 45         | A-3309       |
| 60         | A-3310       |
| 75         | A-3311       |
| 90         | A-3312       |
| 120        | A-3313       |
| 150        | A-3314       |
| 180        | A-3315       |
| 210        | A-3316       |
| 240        | A-3317       |

## Panel liso



| Ancho      | Altura 19 cm |
|------------|--------------|
| Referencia |              |
| 45         | A-3320       |
| 60         | A-3321       |
| 75         | A-3322       |
| 90         | A-3323       |
| 120        | A-3324       |
| 150        | A-3325       |
| 180        | A-3326       |
| 210        | A-3327       |
| 240        | A-3328       |

| Ancho      | Altura 25 cm |
|------------|--------------|
| Referencia |              |
| 45         | A-3330       |
| 60         | A-3331       |
| 75         | A-3332       |
| 90         | A-3333       |
| 120        | A-3334       |
| 150        | A-3335       |
| 180        | A-3336       |
| 210        | A-3337       |
| 240        | A-3338       |

| Ancho      | Altura 37 cm |
|------------|--------------|
| Referencia |              |
| 45         | A-3340       |
| 60         | A-3341       |
| 75         | A-3342       |
| 90         | A-3343       |
| 120        | A-3344       |
| 150        | A-3345       |
| 180        | A-3346       |
| 210        | A-3347       |
| 240        | A-3348       |

Fondo total 6 cm.

## Estante alistonado

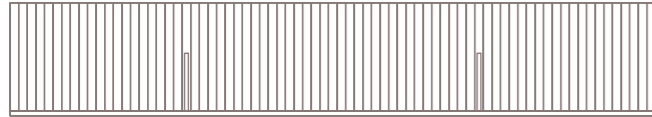
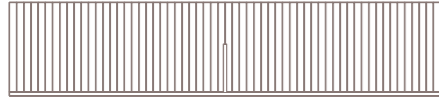

Hasta ancho 120 cm un separador, a partir de ancho 150 cm 2 separadores.  
 Grueso listones 2 cm x 2 cm.  
 Fondo total 28 cm.

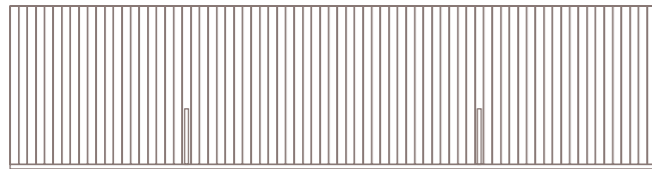
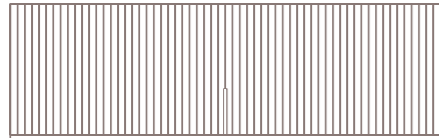

Hasta ancho 120 cm un separador, a partir de ancho 150 cm 2 separadores.  
 Grueso listones 2 cm x 2 cm.  
 Fondo total 28 cm.

| Ancho      | Altura 25 cm |
|------------|--------------|
| Referencia |              |
| 45         | A-3350       |
| 60         | A-3351       |
| 75         | A-3352       |
| 90         | A-3353       |
| 120        | A-3354       |
| 150        | A-3355       |
| 180        | A-3356       |
| 210        | A-3357       |
| 240        | A-3358       |

| Ancho      | Altura 37 cm |
|------------|--------------|
| Referencia |              |
| 45         | A-3359       |
| 60         | A-3360       |
| 75         | A-3361       |
| 90         | A-3362       |
| 120        | A-3363       |
| 150        | A-3364       |
| 180        | A-3365       |
| 210        | A-3366       |
| 240        | A-3367       |

## Panel alistonado

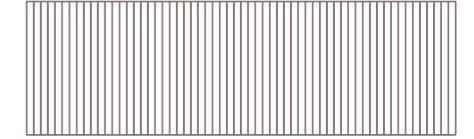
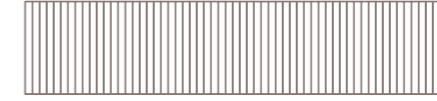

| Ancho      | Altura 19 cm |
|------------|--------------|
| Referencia |              |
| 45         | A-3370       |
| 60         | A-3371       |
| 75         | A-3372       |
| 90         | A-3373       |
| 120        | A-3374       |
| 150        | A-3375       |
| 180        | A-3376       |
| 210        | A-3377       |
| 240        | A-3378       |

| Ancho      | Altura 25 cm |
|------------|--------------|
| Referencia |              |
| 45         | A-3380       |
| 60         | A-3381       |
| 75         | A-3382       |
| 90         | A-3383       |
| 120        | A-3384       |
| 150        | A-3385       |
| 180        | A-3386       |
| 210        | A-3387       |
| 240        | A-3388       |

| Ancho      | Altura 37 cm |
|------------|--------------|
| Referencia |              |
| 45         | A-3390       |
| 60         | A-3391       |
| 75         | A-3392       |
| 90         | A-3393       |
| 120        | A-3394       |
| 150        | A-3395       |
| 180        | A-3396       |
| 210        | A-3397       |
| 240        | A-3398       |

Grueso listones 2 cm x 2 cm.  
 Fondo total 8 cm.

## Estante combinado

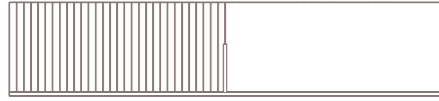

Hasta ancho 120 cm un separador, a partir de ancho 150 cm 2 separadores.  
Fondo total 28 cm.  
Gueso listones 2 cm x 2 cm.

| Ancho      | Altura 25 cm |
|------------|--------------|
| Referencia |              |
| 90         | A-3400       |
| 120        | A-3401       |
| 150        | A-3402       |
| 180        | A-3403       |
| 210        | A-3404       |
| 240        | A-3405       |

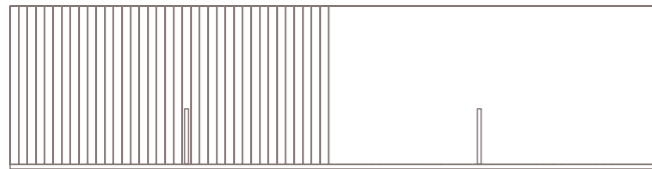
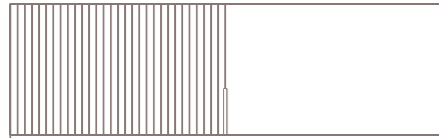

Hasta ancho 120 cm un separador, a partir de ancho 150 cm 2 separadores.  
Fondo total 28 cm.  
Gueso listones 2 cm x 2 cm.

| Ancho      | Altura 37 cm |
|------------|--------------|
| Referencia |              |
| 90         | A-3406       |
| 120        | A-3407       |
| 150        | A-3408       |
| 180        | A-3409       |
| 210        | A-3410       |
| 240        | A-3411       |

## Panel combinado

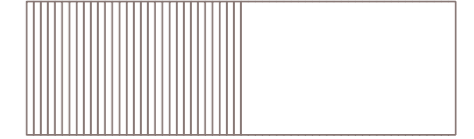
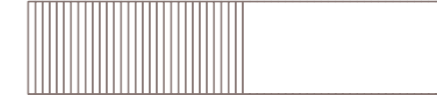

| Ancho      | Altura 19 cm |
|------------|--------------|
| Referencia |              |
| 90         | A-3420       |
| 120        | A-3421       |
| 150        | A-3422       |
| 180        | A-3423       |
| 210        | A-3424       |
| 240        | A-3425       |

| Ancho      | Altura 25 cm |
|------------|--------------|
| Referencia |              |
| 90         | A-3430       |
| 120        | A-3431       |
| 150        | A-3432       |
| 180        | A-3433       |
| 210        | A-3434       |
| 240        | A-3435       |

| Ancho      | Altura 37 cm |
|------------|--------------|
| Referencia |              |
| 90         | A-3440       |
| 120        | A-3441       |
| 150        | A-3442       |
| 180        | A-3443       |
| 210        | A-3444       |
| 240        | A-3445       |

Gueso listones 2 cm x 2 cm.  
Fondo total 6 / 8 cm.

## Acabados estantería ART

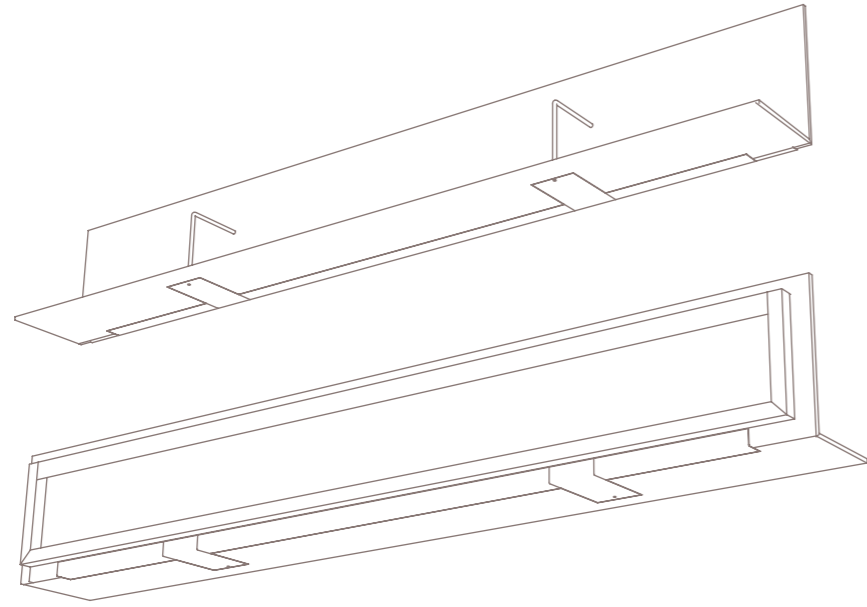

Los estantes ART están compuestos con partes de madera (plafón y estante) y partes metálicas (separadores y base estante). Se puede personalizar su aspecto final según la gama de acabados que proporciona el fabricante.

