

NIGHT COLLECTION

# ARMARIOS VESTIDORES

TARIFA TÉCNICA

**Besform**

# índice

- 004 | ARMARIOS CORREDERAS ALUMINIO
- 008 | ARMARIOS CORREDERAS MADERA GRUESO 5 cm
- 010 | ARMARIOS CORREDERAS MADERA GRUESO 3 cm
- 012 | ARMARIOS BATIENTES
- 022 | ARMARIOS PLEGABLES
- 026 | ARMARIOS COPLANAR
- 027 | ARMARIOS Y COMPLEMENTOS NOVO
- 033 | COMPLEMENTOS ARMARIOS
- 040 | VESTIDORES VISTA
- 058 | PUERTAS CORREDERAS DE ALUMINIO VISTA

## Armarios 2 puertas correderas de aluminio • fondo 67 cm

**NOTA.**

- Interior de chapa sintética, color AC y de 3 cm de grosor (costados y estantes).
- Costados en chapa sintética descontar 50 puntos por costado.
- Puertas con amortiguación y regulación del nivel en interior.
- Se debe restar un mínimo de 4 cm de alto a la altura del techo para poder colgar las puertas.
- Lacar perfil aluminio en colores standar 75 puntos más por puerta.
- Cristales ópticos para igualar color laca incremento 50 puntos por m<sup>2</sup>.
- Cristales mate ópticos, incremento 110 puntos por m<sup>2</sup>.



Interiores	Vidrios Pintados 2 cuadros por puerta	Madera 2 cuadros por puerta	Vidrios Pintados 3 cuadros por puerta	Vidrios Pintados y Madera 3 cuadros por puerta
	<b>alto ancho ref.</b>	<b>alto ancho ref.</b>	<b>alto ancho ref.</b>	<b>alto ancho ref.</b>
	242 157 80000	242 157 80006	242 157 80012	242 157 80018
	242 197 80001	242 197 80007	242 197 80013	242 197 80019
	242 237 80002	242 237 80008	242 237 80014	242 237 80020
	242 257 80003	242 257 80009	242 257 80015	242 257 80021
	242 277 80004	242 277 80010	242 277 80016	242 277 80022
	242 297 80005	242 297 80011	242 297 80017	242 297 80023
	<b>alto ancho ref.</b>	<b>alto ancho ref.</b>	<b>alto ancho ref.</b>	<b>alto ancho ref.</b>
	272 157 80048	272 157 80054	272 157 80060	272 157 80066
	272 197 80049	272 197 80055	272 197 80061	272 197 80067
272 237 80050	272 237 80056	272 237 80062	272 237 80068	
272 257 80051	272 257 80057	272 257 80063	272 257 80069	
272 277 80052	272 277 80058	272 277 80064	272 277 80070	
272 297 80053	272 297 80059	272 297 80065	272 297 80071	

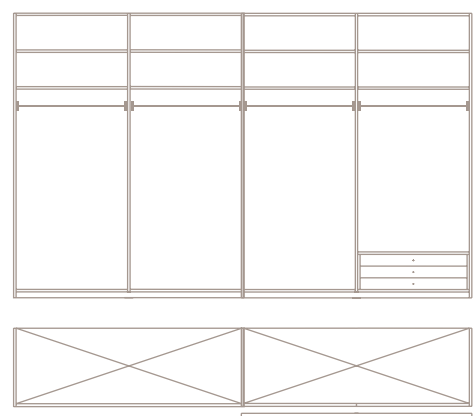

No se aconseja poner todo de cristal con estas medidas tan grandes.

<b>alto ancho ref.</b>	<b>alto ancho ref.</b>
242 317 80096	242 317 80101
242 337 80097	242 337 80102
242 357 80098	242 357 80103
242 377 80099	242 377 80104
242 397 80100	242 397 80105
<b>alto ancho ref.</b>	<b>alto ancho ref.</b>
272 317 80126	272 317 80131
272 337 80127	272 337 80132
272 357 80128	272 357 80133
272 377 80129	272 377 80134
272 397 80130	272 397 80135

## Armarios 2 puertas correderas de aluminio • fondo 67 cm

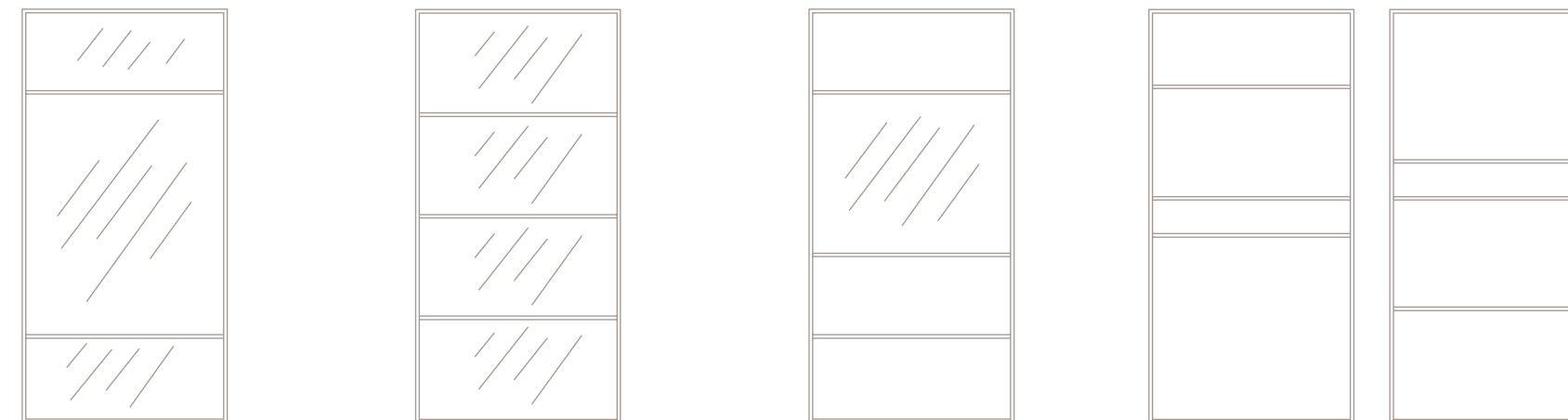

Vidrios Pintados 3 cuadros por puerta	Vidrios Pintados 4 cuadros por puerta	Vidrios Pintados y Madera 4 cuadros por puerta	4 cuadros por puerta desiguales
<b>alto ancho ref.</b>	<b>alto ancho ref.</b>	<b>alto ancho ref.</b>	<b>alto ancho ref.</b>
242 157 80024	242 157 80030	242 157 80036	242 157 80042
242 197 80025	242 197 80031	242 197 80037	242 197 80043
242 237 80026	242 237 80032	242 237 80038	242 237 80044
242 257 80027	242 257 80033	242 257 80039	242 257 80045
242 277 80028	242 277 80034	242 277 80040	242 277 80046
242 297 80029	242 297 80035	242 297 80041	242 297 80047
<b>alto ancho ref.</b>	<b>alto ancho ref.</b>	<b>alto ancho ref.</b>	<b>alto ancho ref.</b>
272 157 80072	272 157 80078	272 157 80084	272 157 80090
272 197 80073	272 197 80079	272 197 80085	272 197 80091
272 237 80074	272 237 80080	272 237 80086	272 237 80092
272 257 80075	272 257 80081	272 257 80087	272 257 80093
272 277 80076	272 277 80082	272 277 80088	272 277 80094
272 297 80077	272 297 80083	272 297 80089	272 297 80095

<b>alto ancho ref.</b>	<b>alto ancho ref.</b>	<b>alto ancho ref.</b>	<b>alto ancho ref.</b>
242 317 80106	242 317 80111	242 317 80116	242 317 80121
242 337 80107	242 337 80112	242 337 80117	242 337 80122
242 357 80108	242 357 80113	242 357 80118	242 357 80123
242 377 80109	242 377 80114	242 377 80119	242 377 80124
242 397 80110	242 397 80115	242 397 80120	242 397 80125
<b>alto ancho ref.</b>	<b>alto ancho ref.</b>	<b>alto ancho ref.</b>	<b>alto ancho ref.</b>
272 317 80136	272 317 80141	272 317 80146	272 317 80151
272 337 80137	272 337 80142	272 337 80147	272 337 80152
272 357 80138	272 357 80143	272 357 80148	272 357 80153
272 377 80139	272 377 80144	272 377 80149	272 377 80154
272 397 80140	272 397 80145	272 397 80150	272 397 80155

## Armarios 3 puertas correderas de aluminio • fondo 67 cm

**NOTA.**

- Interior de chapa sintética, color AC y de 3 cm de grosor (costados y estantes).
- Costados en chapa sintética descontar 50 puntos por costado.
- Puertas con amortiguación y regulación del nivel en interior.
- Se debe restar un mínimo de 4 cm de alto a la altura del techo para poder colgar las puertas.
- Lacar perfil aluminio en colores standar 75 puntos más por puerta.
- Cristales ópticos para igualar color laca incremento 50 puntos por m<sup>2</sup>.
- Cristales mate ópticos, incremento 110 puntos por m<sup>2</sup>.

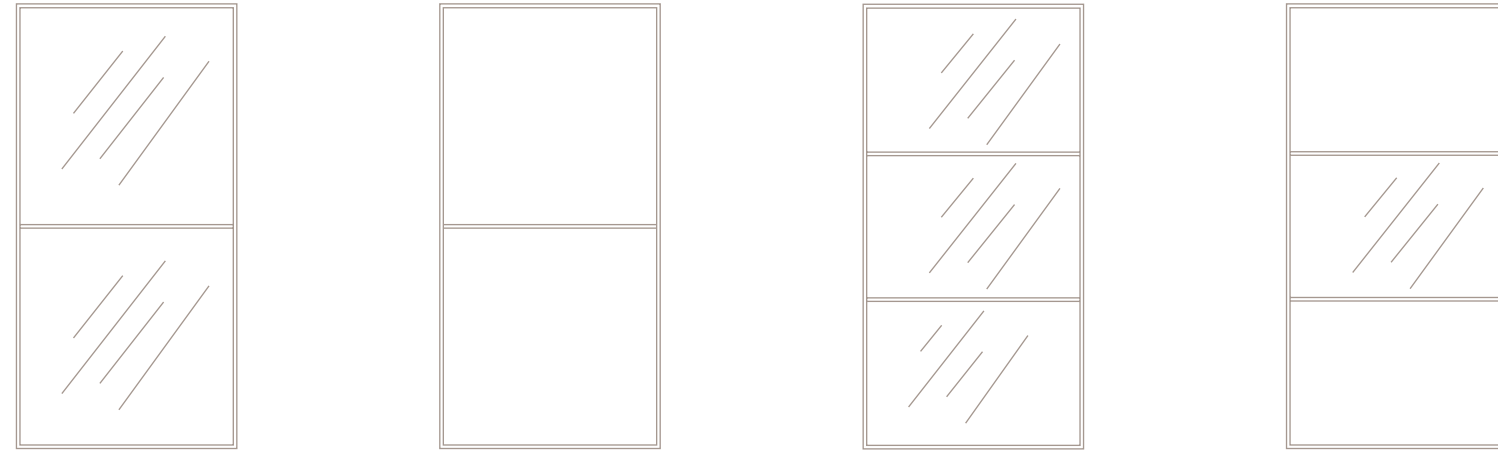

Interiores	Vidrios Pintados 2 cuadros por puerta	Madera 2 cuadros por puerta	Vidrios Pintados 3 cuadros por puerta	Vidrios Pintados y Madera 3 cuadros por puerta																																																												
	<table border="1"> <thead> <tr><th>alto</th><th>ancho</th><th>ref.</th></tr> </thead> <tbody> <tr><td>242</td><td>237</td><td>80156</td></tr> <tr><td>242</td><td>257</td><td>80157</td></tr> <tr><td>242</td><td>277</td><td>80158</td></tr> <tr><td>242</td><td>297</td><td>80159</td></tr> </tbody> </table>	alto	ancho	ref.	242	237	80156	242	257	80157	242	277	80158	242	297	80159	<table border="1"> <thead> <tr><th>alto</th><th>ancho</th><th>ref.</th></tr> </thead> <tbody> <tr><td>242</td><td>237</td><td>80160</td></tr> <tr><td>242</td><td>257</td><td>80161</td></tr> <tr><td>242</td><td>277</td><td>80162</td></tr> <tr><td>242</td><td>297</td><td>80163</td></tr> </tbody> </table>	alto	ancho	ref.	242	237	80160	242	257	80161	242	277	80162	242	297	80163	<table border="1"> <thead> <tr><th>alto</th><th>ancho</th><th>ref.</th></tr> </thead> <tbody> <tr><td>242</td><td>237</td><td>80164</td></tr> <tr><td>242</td><td>257</td><td>80165</td></tr> <tr><td>242</td><td>277</td><td>80166</td></tr> <tr><td>242</td><td>297</td><td>80167</td></tr> </tbody> </table>	alto	ancho	ref.	242	237	80164	242	257	80165	242	277	80166	242	297	80167	<table border="1"> <thead> <tr><th>alto</th><th>ancho</th><th>ref.</th></tr> </thead> <tbody> <tr><td>242</td><td>237</td><td>80168</td></tr> <tr><td>242</td><td>257</td><td>80169</td></tr> <tr><td>242</td><td>277</td><td>80170</td></tr> <tr><td>242</td><td>297</td><td>80171</td></tr> </tbody> </table>	alto	ancho	ref.	242	237	80168	242	257	80169	242	277	80170	242	297	80171
alto	ancho	ref.																																																														
242	237	80156																																																														
242	257	80157																																																														
242	277	80158																																																														
242	297	80159																																																														
alto	ancho	ref.																																																														
242	237	80160																																																														
242	257	80161																																																														
242	277	80162																																																														
242	297	80163																																																														
alto	ancho	ref.																																																														
242	237	80164																																																														
242	257	80165																																																														
242	277	80166																																																														
242	297	80167																																																														
alto	ancho	ref.																																																														
242	237	80168																																																														
242	257	80169																																																														
242	277	80170																																																														
242	297	80171																																																														
	<table border="1"> <thead> <tr><th>alto</th><th>ancho</th><th>ref.</th></tr> </thead> <tbody> <tr><td>272</td><td>237</td><td>80188</td></tr> <tr><td>272</td><td>257</td><td>80189</td></tr> <tr><td>272</td><td>277</td><td>80190</td></tr> <tr><td>272</td><td>297</td><td>80191</td></tr> </tbody> </table>	alto	ancho	ref.	272	237	80188	272	257	80189	272	277	80190	272	297	80191	<table border="1"> <thead> <tr><th>alto</th><th>ancho</th><th>ref.</th></tr> </thead> <tbody> <tr><td>272</td><td>237</td><td>80192</td></tr> <tr><td>272</td><td>257</td><td>80193</td></tr> <tr><td>272</td><td>277</td><td>80194</td></tr> <tr><td>272</td><td>297</td><td>80195</td></tr> </tbody> </table>	alto	ancho	ref.	272	237	80192	272	257	80193	272	277	80194	272	297	80195	<table border="1"> <thead> <tr><th>alto</th><th>ancho</th><th>ref.</th></tr> </thead> <tbody> <tr><td>272</td><td>237</td><td>80196</td></tr> <tr><td>272</td><td>257</td><td>80197</td></tr> <tr><td>272</td><td>277</td><td>80198</td></tr> <tr><td>272</td><td>297</td><td>80199</td></tr> </tbody> </table>	alto	ancho	ref.	272	237	80196	272	257	80197	272	277	80198	272	297	80199	<table border="1"> <thead> <tr><th>alto</th><th>ancho</th><th>ref.</th></tr> </thead> <tbody> <tr><td>272</td><td>237</td><td>80200</td></tr> <tr><td>272</td><td>257</td><td>80201</td></tr> <tr><td>272</td><td>277</td><td>80202</td></tr> <tr><td>272</td><td>297</td><td>80203</td></tr> </tbody> </table>	alto	ancho	ref.	272	237	80200	272	257	80201	272	277	80202	272	297	80203
alto	ancho	ref.																																																														
272	237	80188																																																														
272	257	80189																																																														
272	277	80190																																																														
272	297	80191																																																														
alto	ancho	ref.																																																														
272	237	80192																																																														
272	257	80193																																																														
272	277	80194																																																														
272	297	80195																																																														
alto	ancho	ref.																																																														
272	237	80196																																																														
272	257	80197																																																														
272	277	80198																																																														
272	297	80199																																																														
alto	ancho	ref.																																																														
272	237	80200																																																														
272	257	80201																																																														
272	277	80202																																																														
272	297	80203																																																														

	<table border="1"> <thead> <tr><th>alto</th><th>ancho</th><th>ref.</th></tr> </thead> <tbody> <tr><td>242</td><td>317</td><td>80220</td></tr> <tr><td>242</td><td>337</td><td>80221</td></tr> <tr><td>242</td><td>357</td><td>80222</td></tr> <tr><td>242</td><td>377</td><td>80223</td></tr> <tr><td>242</td><td>397</td><td>80224</td></tr> </tbody> </table>	alto	ancho	ref.	242	317	80220	242	337	80221	242	357	80222	242	377	80223	242	397	80224	<table border="1"> <thead> <tr><th>alto</th><th>ancho</th><th>ref.</th></tr> </thead> <tbody> <tr><td>242</td><td>317</td><td>80225</td></tr> <tr><td>242</td><td>337</td><td>80226</td></tr> <tr><td>242</td><td>357</td><td>80227</td></tr> <tr><td>242</td><td>377</td><td>80228</td></tr> <tr><td>242</td><td>397</td><td>80229</td></tr> </tbody> </table>	alto	ancho	ref.	242	317	80225	242	337	80226	242	357	80227	242	377	80228	242	397	80229	<table border="1"> <thead> <tr><th>alto</th><th>ancho</th><th>ref.</th></tr> </thead> <tbody> <tr><td>242</td><td>317</td><td>80230</td></tr> <tr><td>242</td><td>337</td><td>80231</td></tr> <tr><td>242</td><td>357</td><td>80232</td></tr> <tr><td>242</td><td>377</td><td>80233</td></tr> <tr><td>242</td><td>397</td><td>80234</td></tr> </tbody> </table>	alto	ancho	ref.	242	317	80230	242	337	80231	242	357	80232	242	377	80233	242	397	80234	<table border="1"> <thead> <tr><th>alto</th><th>ancho</th><th>ref.</th></tr> </thead> <tbody> <tr><td>242</td><td>317</td><td>80235</td></tr> <tr><td>242</td><td>337</td><td>80236</td></tr> <tr><td>242</td><td>357</td><td>80237</td></tr> <tr><td>242</td><td>377</td><td>80238</td></tr> <tr><td>242</td><td>397</td><td>80239</td></tr> </tbody> </table>	alto	ancho	ref.	242	317	80235	242	337	80236	242	357	80237	242	377	80238	242	397	80239
alto	ancho	ref.																																																																										
242	317	80220																																																																										
242	337	80221																																																																										
242	357	80222																																																																										
242	377	80223																																																																										
242	397	80224																																																																										
alto	ancho	ref.																																																																										
242	317	80225																																																																										
242	337	80226																																																																										
242	357	80227																																																																										
242	377	80228																																																																										
242	397	80229																																																																										
alto	ancho	ref.																																																																										
242	317	80230																																																																										
242	337	80231																																																																										
242	357	80232																																																																										
242	377	80233																																																																										
242	397	80234																																																																										
alto	ancho	ref.																																																																										
242	317	80235																																																																										
242	337	80236																																																																										
242	357	80237																																																																										
242	377	80238																																																																										
242	397	80239																																																																										
	<table border="1"> <thead> <tr><th>alto</th><th>ancho</th><th>ref.</th></tr> </thead> <tbody> <tr><td>272</td><td>317</td><td>80260</td></tr> <tr><td>272</td><td>337</td><td>80261</td></tr> <tr><td>272</td><td>357</td><td>80262</td></tr> <tr><td>272</td><td>377</td><td>80263</td></tr> <tr><td>272</td><td>397</td><td>80264</td></tr> </tbody> </table>	alto	ancho	ref.	272	317	80260	272	337	80261	272	357	80262	272	377	80263	272	397	80264	<table border="1"> <thead> <tr><th>alto</th><th>ancho</th><th>ref.</th></tr> </thead> <tbody> <tr><td>272</td><td>317</td><td>80265</td></tr> <tr><td>272</td><td>337</td><td>80266</td></tr> <tr><td>272</td><td>357</td><td>80267</td></tr> <tr><td>272</td><td>377</td><td>80268</td></tr> <tr><td>272</td><td>397</td><td>80269</td></tr> </tbody> </table>	alto	ancho	ref.	272	317	80265	272	337	80266	272	357	80267	272	377	80268	272	397	80269	<table border="1"> <thead> <tr><th>alto</th><th>ancho</th><th>ref.</th></tr> </thead> <tbody> <tr><td>272</td><td>317</td><td>80270</td></tr> <tr><td>272</td><td>337</td><td>80271</td></tr> <tr><td>272</td><td>357</td><td>80272</td></tr> <tr><td>272</td><td>377</td><td>80273</td></tr> <tr><td>272</td><td>397</td><td>80274</td></tr> </tbody> </table>	alto	ancho	ref.	272	317	80270	272	337	80271	272	357	80272	272	377	80273	272	397	80274	<table border="1"> <thead> <tr><th>alto</th><th>ancho</th><th>ref.</th></tr> </thead> <tbody> <tr><td>272</td><td>317</td><td>80275</td></tr> <tr><td>272</td><td>337</td><td>80276</td></tr> <tr><td>272</td><td>357</td><td>80277</td></tr> <tr><td>272</td><td>377</td><td>80278</td></tr> <tr><td>272</td><td>397</td><td>80279</td></tr> </tbody> </table>	alto	ancho	ref.	272	317	80275	272	337	80276	272	357	80277	272	377	80278	272	397	80279
alto	ancho	ref.																																																																										
272	317	80260																																																																										
272	337	80261																																																																										
272	357	80262																																																																										
272	377	80263																																																																										
272	397	80264																																																																										
alto	ancho	ref.																																																																										
272	317	80265																																																																										
272	337	80266																																																																										
272	357	80267																																																																										
272	377	80268																																																																										
272	397	80269																																																																										
alto	ancho	ref.																																																																										
272	317	80270																																																																										
272	337	80271																																																																										
272	357	80272																																																																										
272	377	80273																																																																										
272	397	80274																																																																										
alto	ancho	ref.																																																																										
272	317	80275																																																																										
272	337	80276																																																																										
272	357	80277																																																																										
272	377	80278																																																																										
272	397	80279																																																																										

## Armarios 3 puertas correderas de aluminio • fondo 67 cm

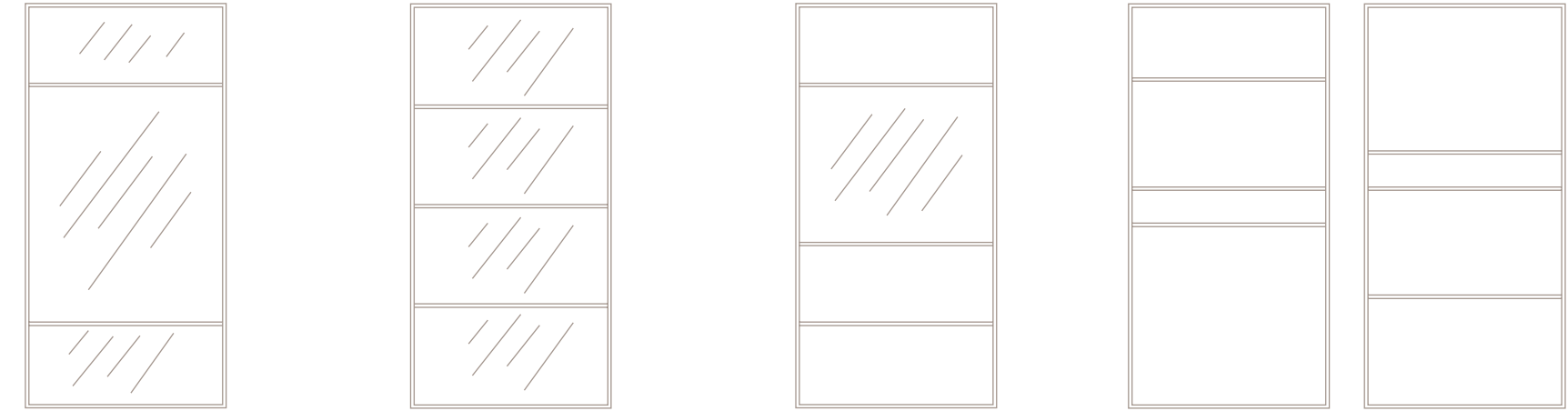

Vidrios Pintados 3 cuadros por puerta	Vidrios Pintados 4 cuadros por puerta	Vidrios Pintados y Madera 4 cuadros por puerta	4 cuadros por puerta desiguales																																																												
<table border="1"> <thead> <tr><th>alto</th><th>ancho</th><th>ref.</th></tr> </thead> <tbody> <tr><td>242</td><td>237</td><td>80172</td></tr> <tr><td>242</td><td>257</td><td>80173</td></tr> <tr><td>242</td><td>277</td><td>80174</td></tr> <tr><td>242</td><td>297</td><td>80175</td></tr> </tbody> </table>	alto	ancho	ref.	242	237	80172	242	257	80173	242	277	80174	242	297	80175	<table border="1"> <thead> <tr><th>alto</th><th>ancho</th><th>ref.</th></tr> </thead> <tbody> <tr><td>242</td><td>237</td><td>80176</td></tr> <tr><td>242</td><td>257</td><td>80177</td></tr> <tr><td>242</td><td>277</td><td>80178</td></tr> <tr><td>242</td><td>297</td><td>80179</td></tr> </tbody> </table>	alto	ancho	ref.	242	237	80176	242	257	80177	242	277	80178	242	297	80179	<table border="1"> <thead> <tr><th>alto</th><th>ancho</th><th>ref.</th></tr> </thead> <tbody> <tr><td>242</td><td>237</td><td>80180</td></tr> <tr><td>242</td><td>257</td><td>80181</td></tr> <tr><td>242</td><td>277</td><td>80182</td></tr> <tr><td>242</td><td>297</td><td>80183</td></tr> </tbody> </table>	alto	ancho	ref.	242	237	80180	242	257	80181	242	277	80182	242	297	80183	<table border="1"> <thead> <tr><th>alto</th><th>ancho</th><th>ref.</th></tr> </thead> <tbody> <tr><td>242</td><td>237</td><td>80184</td></tr> <tr><td>242</td><td>257</td><td>80185</td></tr> <tr><td>242</td><td>277</td><td>80186</td></tr> <tr><td>242</td><td>297</td><td>80187</td></tr> </tbody> </table>	alto	ancho	ref.	242	237	80184	242	257	80185	242	277	80186	242	297	80187
alto	ancho	ref.																																																													
242	237	80172																																																													
242	257	80173																																																													
242	277	80174																																																													
242	297	80175																																																													
alto	ancho	ref.																																																													
242	237	80176																																																													
242	257	80177																																																													
242	277	80178																																																													
242	297	80179																																																													
alto	ancho	ref.																																																													
242	237	80180																																																													
242	257	80181																																																													
242	277	80182																																																													
242	297	80183																																																													
alto	ancho	ref.																																																													
242	237	80184																																																													
242	257	80185																																																													
242	277	80186																																																													
242	297	80187																																																													
<table border="1"> <thead> <tr><th>alto</th><th>ancho</th><th>ref.</th></tr> </thead> <tbody> <tr><td>272</td><td>237</td><td>80204</td></tr> <tr><td>272</td><td>257</td><td>80205</td></tr> <tr><td>272</td><td>277</td><td>80206</td></tr> <tr><td>272</td><td>297</td><td>80207</td></tr> </tbody> </table>	alto	ancho	ref.	272	237	80204	272	257	80205	272	277	80206	272	297	80207	<table border="1"> <thead> <tr><th>alto</th><th>ancho</th><th>ref.</th></tr> </thead> <tbody> <tr><td>272</td><td>237</td><td>80208</td></tr> <tr><td>272</td><td>257</td><td>80209</td></tr> <tr><td>272</td><td>277</td><td>80210</td></tr> <tr><td>272</td><td>297</td><td>80211</td></tr> </tbody> </table>	alto	ancho	ref.	272	237	80208	272	257	80209	272	277	80210	272	297	80211	<table border="1"> <thead> <tr><th>alto</th><th>ancho</th><th>ref.</th></tr> </thead> <tbody> <tr><td>272</td><td>237</td><td>80212</td></tr> <tr><td>272</td><td>257</td><td>80213</td></tr> <tr><td>272</td><td>277</td><td>80214</td></tr> <tr><td>272</td><td>297</td><td>80215</td></tr> </tbody> </table>	alto	ancho	ref.	272	237	80212	272	257	80213	272	277	80214	272	297	80215	<table border="1"> <thead> <tr><th>alto</th><th>ancho</th><th>ref.</th></tr> </thead> <tbody> <tr><td>272</td><td>237</td><td>80216</td></tr> <tr><td>272</td><td>257</td><td>80217</td></tr> <tr><td>272</td><td>277</td><td>80218</td></tr> <tr><td>272</td><td>297</td><td>80219</td></tr> </tbody> </table>	alto	ancho	ref.	272	237	80216	272	257	80217	272	277	80218	272	297	80219
alto	ancho	ref.																																																													
272	237	80204																																																													
272	257	80205																																																													
272	277	80206																																																													
272	297	80207																																																													
alto	ancho	ref.																																																													
272	237	80208																																																													
272	257	80209																																																													
272	277	80210																																																													
272	297	80211																																																													
alto	ancho	ref.																																																													
272	237	80212																																																													
272	257	80213																																																													
272	277	80214																																																													
272	297	80215																																																													
alto	ancho	ref.																																																													
272	237	80216																																																													
272	257	80217																																																													
272	277	80218																																																													
272	297	80219																																																													

<table border="1"> <thead> <tr><th>alto</th><th>ancho</th><th>ref.</th></tr> </thead> <tbody> <tr><td>242</td><td>317</td><td>80240</td></tr> <tr><td>242</td><td>337</td><td>80241</td></tr> <tr><td>242</td><td>357</td><td>80242</td></tr> <tr><td>242</td><td>377</td><td>80243</td></tr> <tr><td>242</td><td>397</td><td>80244</td></tr> </tbody> </table>	alto	ancho	ref.	242	317	80240	242	337	80241	242	357	80242	242	377	80243	242	397	80244	<table border="1"> <thead> <tr><th>alto</th><th>ancho</th><th>ref.</th></tr> </thead> <tbody> <tr><td>242</td><td>317</td><td>80245</td></tr> <tr><td>242</td><td>337</td><td>80246</td></tr> <tr><td>242</td><td>357</td><td>80247</td></tr> <tr><td>242</td><td>377</td><td>80248</td></tr> <tr><td>242</td><td>397</td><td>80249</td></tr> </tbody> </table>	alto	ancho	ref.	242	317	80245	242	337	80246	242	357	80247	242	377	80248	242	397	80249	<table border="1"> <thead> <tr><th>alto</th><th>ancho</th><th>ref.</th></tr> </thead> <tbody> <tr><td>242</td><td>317</td><td>80250</td></tr> <tr><td>242</td><td>337</td><td>80251</td></tr> <tr><td>242</td><td>357</td><td>80252</td></tr> <tr><td>242</td><td>377</td><td>80253</td></tr> <tr><td>242</td><td>397</td><td>80254</td></tr> </tbody> </table>	alto	ancho	ref.	242	317	80250	242	337	80251	242	357	80252	242	377	80253	242	397	80254	<table border="1"> <thead> <tr><th>alto</th><th>ancho</th><th>ref.</th></tr> </thead> <tbody> <tr><td>242</td><td>317</td><td>80255</td></tr> <tr><td>242</td><td>337</td><td>80256</td></tr> <tr><td>242</td><td>357</td><td>80257</td></tr> <tr><td>242</td><td>377</td><td>80258</td></tr> <tr><td>242</td><td>397</td><td>80259</td></tr> </tbody> </table>	alto	ancho	ref.	242	317	80255	242	337	80256	242	357	80257	242	377	80258	242	397	80259
alto	ancho	ref.																																																																									
242	317	80240																																																																									
242	337	80241																																																																									
242	357	80242																																																																									
242	377	80243																																																																									
242	397	80244																																																																									
alto	ancho	ref.																																																																									
242	317	80245																																																																									
242	337	80246																																																																									
242	357	80247																																																																									
242	377	80248																																																																									
242	397	80249																																																																									
alto	ancho	ref.																																																																									
242	317	80250																																																																									
242	337	80251																																																																									
242	357	80252																																																																									
242	377	80253																																																																									
242	397	80254																																																																									
alto	ancho	ref.																																																																									
242	317	80255																																																																									
242	337	80256																																																																									
242	357	80257																																																																									
242	377	80258																																																																									
242	397	80259																																																																									
<table border="1"> <thead> <tr><th>alto</th><th>ancho</th><th>ref.</th></tr> </thead> <tbody> <tr><td>272</td><td>317</td><td>80280</td></tr> <tr><td>272</td><td>337</td><td>80281</td></tr> <tr><td>272</td><td>357</td><td>80282</td></tr> <tr><td>272</td><td>377</td><td>80283</td></tr> <tr><td>272</td><td>397</td><td>80284</td></tr> </tbody> </table>	alto	ancho	ref.	272	317	80280	272	337	80281	272	357	80282	272	377	80283	272	397	80284	<table border="1"> <thead> <tr><th>alto</th><th>ancho</th><th>ref.</th></tr> </thead> <tbody> <tr><td>272</td><td>317</td><td>80285</td></tr> <tr><td>272</td><td>337</td><td>80286</td></tr> <tr><td>272</td><td>357</td><td>80287</td></tr> <tr><td>272</td><td>377</td><td>80288</td></tr> <tr><td>272</td><td>397</td><td>80289</td></tr> </tbody> </table>	alto	ancho	ref.	272	317	80285	272	337	80286	272	357	80287	272	377	80288	272	397	80289	<table border="1"> <thead> <tr><th>alto</th><th>ancho</th><th>ref.</th></tr> </thead> <tbody> <tr><td>272</td><td>317</td><td>80290</td></tr> <tr><td>272</td><td>337</td><td>80291</td></tr> <tr><td>272</td><td>357</td><td>80292</td></tr> <tr><td>272</td><td>377</td><td>80293</td></tr> <tr><td>272</td><td>397</td><td>80294</td></tr> </tbody> </table>	alto	ancho	ref.	272	317	80290	272	337	80291	272	357	80292	272	377	80293	272	397	80294	<table border="1"> <thead> <tr><th>alto</th><th>ancho</th><th>ref.</th></tr> </thead> <tbody> <tr><td>272</td><td>317</td><td>80295</td></tr> <tr><td>272</td><td>337</td><td>80296</td></tr> <tr><td>272</td><td>357</td><td>80297</td></tr> <tr><td>272</td><td>377</td><td>80298</td></tr> <tr><td>272</td><td>397</td><td>80299</td></tr> </tbody> </table>	alto	ancho	ref.	272	317	80295	272	337	80296	272	357	80297	272	377	80298	272	397	80299
alto	ancho	ref.																																																																									
272	317	80280																																																																									
272	337	80281																																																																									
272	357	80282																																																																									
272	377	80283																																																																									
272	397	80284																																																																									
alto	ancho	ref.																																																																									
272	317	80285																																																																									
272	337	80286																																																																									
272	357	80287																																																																									
272	377	80288																																																																									
272	397	80289																																																																									
alto	ancho	ref.																																																																									
272	317	80290																																																																									
272	337	80291																																																																									
272	357	80292																																																																									
272	377	80293																																																																									
272	397	80294																																																																									
alto	ancho	ref.																																																																									
272	317	80295																																																																									
272	337	80296																																																																									
272	357	80297																																																																									
272	377	80298																																																																									
272	397	80299																																																																									

## Armarios 2 y 3 puertas correderas de madera • grueso 5 cm / fondo 71 cm

**NOTA.**

• Interior de chapa sintética, color AC y de 3 cm de grosor (costados y estantes).

• Costados en chapa sintética descontar 50 puntos por costado.

• Puertas con amortiguación y regulación del nivel en interior.

• Se debe restar un mínimo de 4 cm de alto a la altura del techo para poder colgar las puertas.

• Cristales ópticos para igualar color laca incremento 50 puntos por m<sup>2</sup>.

• Cristales mate ópticos, incremento 110 puntos por m<sup>2</sup>.

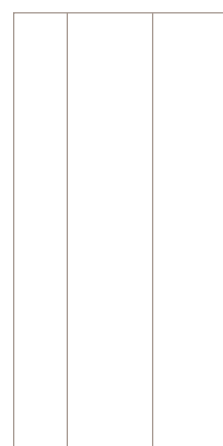
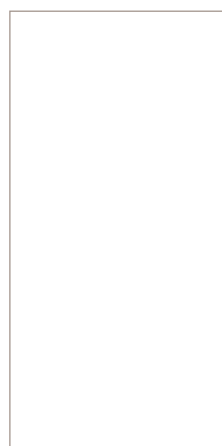

Interiores	Puerta lisa	Puerta seven	Vetas horizontales y combinadas																																													
	<table border="1"> <thead> <tr><th>alto</th><th>ancho</th><th>ref.</th></tr> </thead> <tbody> <tr><td>242</td><td>157</td><td>80300</td></tr> <tr><td>242</td><td>197</td><td>80301</td></tr> <tr><td>242</td><td>215</td><td>80302</td></tr> <tr><td>242</td><td>237</td><td>80303</td></tr> </tbody> </table>	alto	ancho	ref.	242	157	80300	242	197	80301	242	215	80302	242	237	80303	<table border="1"> <thead> <tr><th>alto</th><th>ancho</th><th>ref.</th></tr> </thead> <tbody> <tr><td>242</td><td>157</td><td>80304</td></tr> <tr><td>242</td><td>197</td><td>80305</td></tr> <tr><td>242</td><td>215</td><td>80306</td></tr> <tr><td>242</td><td>237</td><td>80307</td></tr> </tbody> </table>	alto	ancho	ref.	242	157	80304	242	197	80305	242	215	80306	242	237	80307	<table border="1"> <thead> <tr><th>alto</th><th>ancho</th><th>ref.</th></tr> </thead> <tbody> <tr><td>242</td><td>157</td><td>80308</td></tr> <tr><td>242</td><td>197</td><td>80309</td></tr> <tr><td>242</td><td>215</td><td>80310</td></tr> <tr><td>242</td><td>237</td><td>80311</td></tr> </tbody> </table>	alto	ancho	ref.	242	157	80308	242	197	80309	242	215	80310	242	237	80311
	alto	ancho	ref.																																													
242	157	80300																																														
242	197	80301																																														
242	215	80302																																														
242	237	80303																																														
alto	ancho	ref.																																														
242	157	80304																																														
242	197	80305																																														
242	215	80306																																														
242	237	80307																																														
alto	ancho	ref.																																														
242	157	80308																																														
242	197	80309																																														
242	215	80310																																														
242	237	80311																																														
	<table border="1"> <thead> <tr><th>alto</th><th>ancho</th><th>ref.</th></tr> </thead> <tbody> <tr><td>272</td><td>157</td><td>80328</td></tr> <tr><td>272</td><td>197</td><td>80329</td></tr> <tr><td>272</td><td>215</td><td>80330</td></tr> <tr><td>272</td><td>237</td><td>80331</td></tr> </tbody> </table>	alto	ancho	ref.	272	157	80328	272	197	80329	272	215	80330	272	237	80331	<table border="1"> <thead> <tr><th>alto</th><th>ancho</th><th>ref.</th></tr> </thead> <tbody> <tr><td>272</td><td>157</td><td>80332</td></tr> <tr><td>272</td><td>197</td><td>80333</td></tr> <tr><td>272</td><td>215</td><td>80334</td></tr> <tr><td>272</td><td>237</td><td>80335</td></tr> </tbody> </table>	alto	ancho	ref.	272	157	80332	272	197	80333	272	215	80334	272	237	80335	<table border="1"> <thead> <tr><th>alto</th><th>ancho</th><th>ref.</th></tr> </thead> <tbody> <tr><td>272</td><td>157</td><td>80336</td></tr> <tr><td>272</td><td>197</td><td>80337</td></tr> <tr><td>272</td><td>215</td><td>80338</td></tr> <tr><td>272</td><td>237</td><td>80339</td></tr> </tbody> </table>	alto	ancho	ref.	272	157	80336	272	197	80337	272	215	80338	272	237	80339
	alto	ancho	ref.																																													
272	157	80328																																														
272	197	80329																																														
272	215	80330																																														
272	237	80331																																														
alto	ancho	ref.																																														
272	157	80332																																														
272	197	80333																																														
272	215	80334																																														
272	237	80335																																														
alto	ancho	ref.																																														
272	157	80336																																														
272	197	80337																																														
272	215	80338																																														
272	237	80339																																														

	<table border="1"> <thead> <tr><th>alto</th><th>ancho</th><th>ref.</th></tr> </thead> <tbody> <tr><td>242</td><td>257</td><td>80356</td></tr> <tr><td>242</td><td>297</td><td>80357</td></tr> <tr><td>242</td><td>317</td><td>80358</td></tr> </tbody> </table>	alto	ancho	ref.	242	257	80356	242	297	80357	242	317	80358	<table border="1"> <thead> <tr><th>alto</th><th>ancho</th><th>ref.</th></tr> </thead> <tbody> <tr><td>242</td><td>257</td><td>80359</td></tr> <tr><td>242</td><td>297</td><td>80360</td></tr> <tr><td>242</td><td>317</td><td>80361</td></tr> </tbody> </table>	alto	ancho	ref.	242	257	80359	242	297	80360	242	317	80361	<table border="1"> <thead> <tr><th>alto</th><th>ancho</th><th>ref.</th></tr> </thead> <tbody> <tr><td>242</td><td>257</td><td>80362</td></tr> <tr><td>242</td><td>297</td><td>80363</td></tr> <tr><td>242</td><td>317</td><td>80364</td></tr> </tbody> </table>	alto	ancho	ref.	242	257	80362	242	297	80363	242	317	80364
	alto	ancho	ref.																																				
242	257	80356																																					
242	297	80357																																					
242	317	80358																																					
alto	ancho	ref.																																					
242	257	80359																																					
242	297	80360																																					
242	317	80361																																					
alto	ancho	ref.																																					
242	257	80362																																					
242	297	80363																																					
242	317	80364																																					
	<table border="1"> <thead> <tr><th>alto</th><th>ancho</th><th>ref.</th></tr> </thead> <tbody> <tr><td>272</td><td>257</td><td>80377</td></tr> <tr><td>272</td><td>297</td><td>80378</td></tr> <tr><td>272</td><td>317</td><td>80379</td></tr> </tbody> </table>	alto	ancho	ref.	272	257	80377	272	297	80378	272	317	80379	<table border="1"> <thead> <tr><th>alto</th><th>ancho</th><th>ref.</th></tr> </thead> <tbody> <tr><td>272</td><td>257</td><td>80380</td></tr> <tr><td>272</td><td>297</td><td>80381</td></tr> <tr><td>272</td><td>317</td><td>80382</td></tr> </tbody> </table>	alto	ancho	ref.	272	257	80380	272	297	80381	272	317	80382	<table border="1"> <thead> <tr><th>alto</th><th>ancho</th><th>ref.</th></tr> </thead> <tbody> <tr><td>272</td><td>257</td><td>80383</td></tr> <tr><td>272</td><td>297</td><td>80384</td></tr> <tr><td>272</td><td>317</td><td>80385</td></tr> </tbody> </table>	alto	ancho	ref.	272	257	80383	272	297	80384	272	317	80385
	alto	ancho	ref.																																				
272	257	80377																																					
272	297	80378																																					
272	317	80379																																					
alto	ancho	ref.																																					
272	257	80380																																					
272	297	80381																																					
272	317	80382																																					
alto	ancho	ref.																																					
272	257	80383																																					
272	297	80384																																					
272	317	80385																																					

## Armarios 2 y 3 puertas correderas de madera • grueso 5 cm / fondo 71 cm

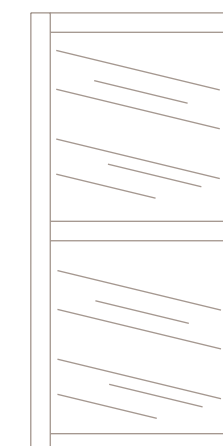
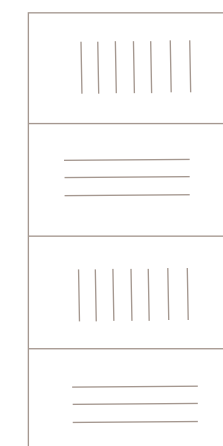

Puertas desiguales	Vetas cruzadas	Marco 15 cm con faja central y vidrio	Puerta H. Wall																																																												
<table border="1"> <thead> <tr><th>alto</th><th>ancho</th><th>ref.</th></tr> </thead> <tbody> <tr><td>242</td><td>157</td><td>80312</td></tr> <tr><td>242</td><td>197</td><td>80313</td></tr> <tr><td>242</td><td>215</td><td>80314</td></tr> <tr><td>242</td><td>237</td><td>80315</td></tr> </tbody> </table>	alto	ancho	ref.	242	157	80312	242	197	80313	242	215	80314	242	237	80315	<table border="1"> <thead> <tr><th>alto</th><th>ancho</th><th>ref.</th></tr> </thead> <tbody> <tr><td>242</td><td>157</td><td>80316</td></tr> <tr><td>242</td><td>197</td><td>80317</td></tr> <tr><td>242</td><td>215</td><td>80318</td></tr> <tr><td>242</td><td>237</td><td>80319</td></tr> </tbody> </table>	alto	ancho	ref.	242	157	80316	242	197	80317	242	215	80318	242	237	80319	<table border="1"> <thead> <tr><th>alto</th><th>ancho</th><th>ref.</th></tr> </thead> <tbody> <tr><td>242</td><td>157</td><td>80320</td></tr> <tr><td>242</td><td>197</td><td>80321</td></tr> <tr><td>242</td><td>215</td><td>80322</td></tr> <tr><td>242</td><td>237</td><td>80323</td></tr> </tbody> </table>	alto	ancho	ref.	242	157	80320	242	197	80321	242	215	80322	242	237	80323	<table border="1"> <thead> <tr><th>alto</th><th>ancho</th><th>ref.</th></tr> </thead> <tbody> <tr><td>242</td><td>157</td><td>N-82000</td></tr> <tr><td>242</td><td>197</td><td>N-82001</td></tr> <tr><td>242</td><td>215</td><td>N-82002</td></tr> <tr><td>242</td><td>237</td><td>N-82003</td></tr> </tbody> </table>	alto	ancho	ref.	242	157	N-82000	242	197	N-82001	242	215	N-82002	242	237	N-82003
alto	ancho	ref.																																																													
242	157	80312																																																													
242	197	80313																																																													
242	215	80314																																																													
242	237	80315																																																													
alto	ancho	ref.																																																													
242	157	80316																																																													
242	197	80317																																																													
242	215	80318																																																													
242	237	80319																																																													
alto	ancho	ref.																																																													
242	157	80320																																																													
242	197	80321																																																													
242	215	80322																																																													
242	237	80323																																																													
alto	ancho	ref.																																																													
242	157	N-82000																																																													
242	197	N-82001																																																													
242	215	N-82002																																																													
242	237	N-82003																																																													
<table border="1"> <thead> <tr><th>alto</th><th>ancho</th><th>ref.</th></tr> </thead> <tbody> <tr><td>272</td><td>157</td><td>80340</td></tr> <tr><td>272</td><td>197</td><td>80341</td></tr> <tr><td>272</td><td>215</td><td>80342</td></tr> <tr><td>272</td><td>237</td><td>80343</td></tr> </tbody> </table>	alto	ancho	ref.	272	157	80340	272	197	80341	272	215	80342	272	237	80343	<table border="1"> <thead> <tr><th>alto</th><th>ancho</th><th>ref.</th></tr> </thead> <tbody> <tr><td>272</td><td>157</td><td>80344</td></tr> <tr><td>272</td><td>197</td><td>80345</td></tr> <tr><td>272</td><td>215</td><td>80346</td></tr> <tr><td>272</td><td>237</td><td>80347</td></tr> </tbody> </table>	alto	ancho	ref.	272	157	80344	272	197	80345	272	215	80346	272	237	80347	<table border="1"> <thead> <tr><th>alto</th><th>ancho</th><th>ref.</th></tr> </thead> <tbody> <tr><td>272</td><td>157</td><td>80348</td></tr> <tr><td>272</td><td>197</td><td>80349</td></tr> <tr><td>272</td><td>215</td><td>80350</td></tr> <tr><td>272</td><td>237</td><td>80351</td></tr> </tbody> </table>	alto	ancho	ref.	272	157	80348	272	197	80349	272	215	80350	272	237	80351	<table border="1"> <thead> <tr><th>alto</th><th>ancho</th><th>ref.</th></tr> </thead> <tbody> <tr><td>272</td><td>157</td><td>N-82011</td></tr> <tr><td>272</td><td>197</td><td>N-82012</td></tr> <tr><td>272</td><td>215</td><td>N-82013</td></tr> <tr><td>272</td><td>237</td><td>N-82014</td></tr> </tbody> </table>	alto	ancho	ref.	272	157	N-82011	272	197	N-82012	272	215	N-82013	272	237	N-82014
alto	ancho	ref.																																																													
272	157	80340																																																													
272	197	80341																																																													
272	215	80342																																																													
272	237	80343																																																													
alto	ancho	ref.																																																													
272	157	80344																																																													
272	197	80345																																																													
272	215	80346																																																													
272	237	80347																																																													
alto	ancho	ref.																																																													
272	157	80348																																																													
272	197	80349																																																													
272	215	80350																																																													
272	237	80351																																																													
alto	ancho	ref.																																																													
272	157	N-82011																																																													
272	197	N-82012																																																													
272	215	N-82013																																																													
272	237	N-82014																																																													

<table border="1"> <thead> <tr><th>alto</th><th>ancho</th><th>ref.</th></tr> </thead> <tbody> <tr><td>242</td><td>257</td><td>80365</td></tr> <tr><td>242</td><td>297</td><td>80366</td></tr> <tr><td>242</td><td>317</td><td>80367</td></tr> </tbody> </table>	alto	ancho	ref.	242	257	80365	242	297	80366	242	317	80367	<table border="1"> <thead> <tr><th>alto</th><th>ancho</th><th>ref.</th></tr> </thead> <tbody> <tr><td>242</td><td>257</td><td>80368</td></tr> <tr><td>242</td><td>297</td><td>80369</td></tr> <tr><td>242</td><td>317</td><td>80370</td></tr> </tbody> </table>	alto	ancho	ref.	242	257	80368	242	297	80369	242	317	80370	<table border="1"> <thead> <tr><th>alto</th><th>ancho</th><th>ref.</th></tr> </thead> <tbody> <tr><td>242</td><td>257</td><td>80371</td></tr> <tr><td>242</td><td>297</td><td>80372</td></tr> <tr><td>242</td><td>317</td><td>80373</td></tr> </tbody> </table>	alto	ancho	ref.	242	257	80371	242	297	80372	242	317	80373	<table border="1"> <thead> <tr><th>alto</th><th>ancho</th><th>ref.</th></tr> </thead> <tbody> <tr><td>242</td><td>257</td><td>N-82022</td></tr> <tr><td>242</td><td>297</td><td>N-82023</td></tr> <tr><td>242</td><td>317</td><td>N-82024</td></tr> </tbody> </table>	alto	ancho	ref.	242	257	N-82022	242	297	N-82023	242	317	N-82024
alto	ancho	ref.																																																	
242	257	80365																																																	
242	297	80366																																																	
242	317	80367																																																	
alto	ancho	ref.																																																	
242	257	80368																																																	
242	297	80369																																																	
242	317	80370																																																	
alto	ancho	ref.																																																	
242	257	80371																																																	
242	297	80372																																																	
242	317	80373																																																	
alto	ancho	ref.																																																	
242	257	N-82022																																																	
242	297	N-82023																																																	
242	317	N-82024																																																	
<table border="1"> <thead> <tr><th>alto</th><th>ancho</th><th>ref.</th></tr> </thead> <tbody> <tr><td>272</td><td>257</td><td>80386</td></tr> <tr><td>272</td><td>297</td><td>80387</td></tr> <tr><td>272</td><td>317</td><td>80388</td></tr> </tbody> </table>	alto	ancho	ref.	272	257	80386	272	297	80387	272	317	80388	<table border="1"> <thead> <tr><th>alto</th><th>ancho</th><th>ref.</th></tr> </thead> <tbody> <tr><td>272</td><td>257</td><td>80389</td></tr> <tr><td>272</td><td>297</td><td>80390</td></tr> <tr><td>272</td><td>317</td><td>80391</td></tr> </tbody> </table>	alto	ancho	ref.	272	257	80389	272	297	80390	272	317	80391	<table border="1"> <thead> <tr><th>alto</th><th>ancho</th><th>ref.</th></tr> </thead> <tbody> <tr><td>272</td><td>257</td><td>80392</td></tr> <tr><td>272</td><td>297</td><td>80393</td></tr> <tr><td>272</td><td>317</td><td>80394</td></tr> </tbody> </table>	alto	ancho	ref.	272	257	80392	272	297	80393	272	317	80394	<table border="1"> <thead> <tr><th>alto</th><th>ancho</th><th>ref.</th></tr> </thead> <tbody> <tr><td>272</td><td>257</td><td>N-82032</td></tr> <tr><td>272</td><td>297</td><td>N-82033</td></tr> <tr><td>272</td><td>317</td><td>N-82034</td></tr> </tbody> </table>	alto	ancho	ref.	272	257	N-82032	272	297	N-82033	272	317	N-82034
alto	ancho	ref.																																																	
272	257	80386																																																	
272	297	80387																																																	
272	317	80388																																																	
alto	ancho	ref.																																																	
272	257	80389																																																	
272	297	80390																																																	
272	317	80391																																																	
alto	ancho	ref.																																																	
272	257	80392																																																	
272	297	80393																																																	
272	317	80394																																																	
alto	ancho	ref.																																																	
272	257	N-82032																																																	
272	297	N-82033																																																	
272	317	N-82034																																																	

## Armarios 2 y 3 puertas correderas de madera • grueso 3 cm / fondo 67 cm

**NOTA.**

• Interior de chapa sintética, color AC y de 3 cm de grosor (costados y estantes).

• Costados en chapa sintética descontar 50 puntos por costado.

• Puertas con amortiguación y regulación del nivel en interior.

• Se debe restar un mínimo de 4 cm de alto a la altura del techo para poder colgar las puertas.

• Cristales ópticos para igualar color laca incremento 50 puntos por m<sup>2</sup>.

• Cristales mate ópticos, incremento 110 puntos por m<sup>2</sup>.

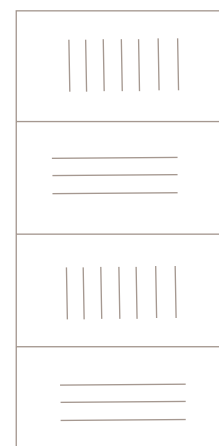
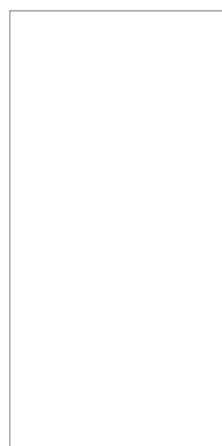

**Interiores** | **Puerta lisa** | **Vetas cruzadas** | **Marco listonado**

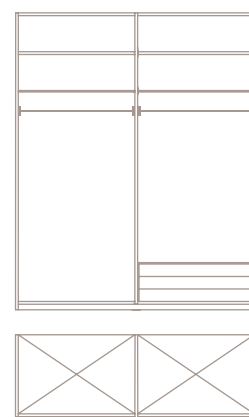

alto	ancho	ref.
242	157	80398
242	197	80399
242	215	80400
242	237	80401

alto	ancho	ref.
242	157	80402
242	197	80403
242	215	80404
242	237	80405

alto	ancho	ref.
242	157	80406
242	197	80407
242	215	80408
242	237	80409

alto	ancho	ref.
272	157	80430
272	197	80431
272	215	80432
272	237	80433

alto	ancho	ref.
272	157	80434
272	197	80435
272	215	80436
272	237	80437

alto	ancho	ref.
272	157	80438
272	197	80439
272	215	80440
272	237	80441

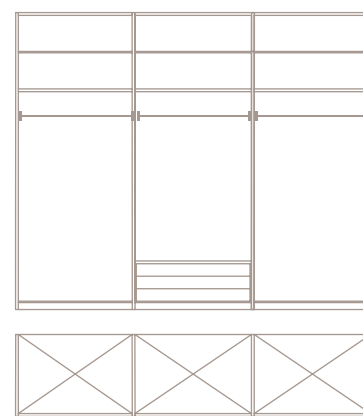

alto	ancho	ref.
242	257	80462
242	297	80463
242	317	80464

alto	ancho	ref.
242	257	80465
242	297	80466
242	317	80467

alto	ancho	ref.
242	257	80468
242	297	80469
242	317	80470

alto	ancho	ref.
272	257	80486
272	297	80487
272	317	80488

alto	ancho	ref.
272	257	80489
272	297	80490
272	317	80491

alto	ancho	ref.
272	257	80492
272	297	80493
272	317	80494

## Armarios 2 y 3 puertas correderas de madera • grueso 3 cm /fondo 67 cm

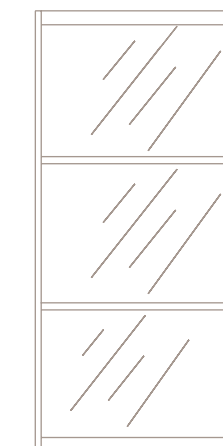
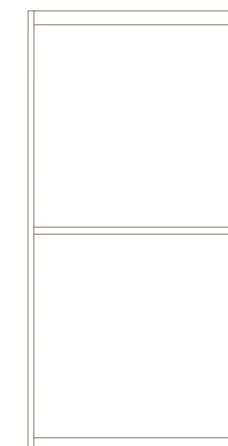
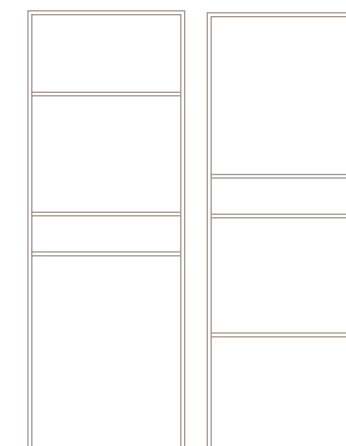
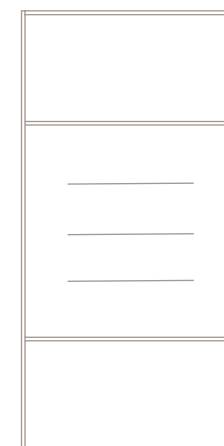

**Marco listonado vetas horizontales y combinado** | **Marco listonado desigual** | **Marco madera** | **Marco vidrio** | **Marco combinado**

alto	ancho	ref.
242	237	80410
242	257	80411
242	277	80412
242	297	80413

alto	ancho	ref.
242	237	80414
242	257	80415
242	277	80416
242	297	80417

alto	ancho	ref.
242	237	80418
242	257	80419
242	277	80420
242	297	80421

alto	ancho	ref.
242	237	80422
242	257	80423
242	277	80424
242	297	80425

alto	ancho	ref.
242	237	80426
242	257	80427
242	277	80428
242	297	80429

alto	ancho	ref.
272	237	80442
272	257	80443
272	277	80444
272	297	80445

alto	ancho	ref.
272	237	80446
272	257	80447
272	277	80448
272	297	80449

alto	ancho	ref.
272	237	80450
272	257	80451
272	277	80452
272	297	80453

alto	ancho	ref.
272	237	80454
272	257	80455
272	277	80456
272	297	80457

alto	ancho	ref.
272	237	80458
272	257	80459
272	277	80460
272	297	80461

alto	ancho	ref.
242	257	80471
242	297	80472
242	317	80473

alto	ancho	ref.
242	257	80474
242	297	80475
242	317	80476

alto	ancho	ref.
242	257	80477
242	297	80478
242	317	80479

alto	ancho	ref.
242	257	80480
242	297	80481
242	317	80482

alto	ancho	ref.
242	257	80483
242	297	80484
242	317	80485

alto	ancho	ref.
272	257	80495
272	297	80496
272	317	80497

alto	ancho	ref.
272	257	80498
272	297	80499
272	317	80500

alto	ancho	ref.
272	257	80501
272	297	80502
272	317	80503

alto	ancho	ref.
272	257	80504
272	297	80505
272	317	80506





alto	ancho	ref.
272	257	80507
272	297	80508
272	317	80509

## Armarios basicos rectos, combinación y chaflán • fondo 62 y 50 cm

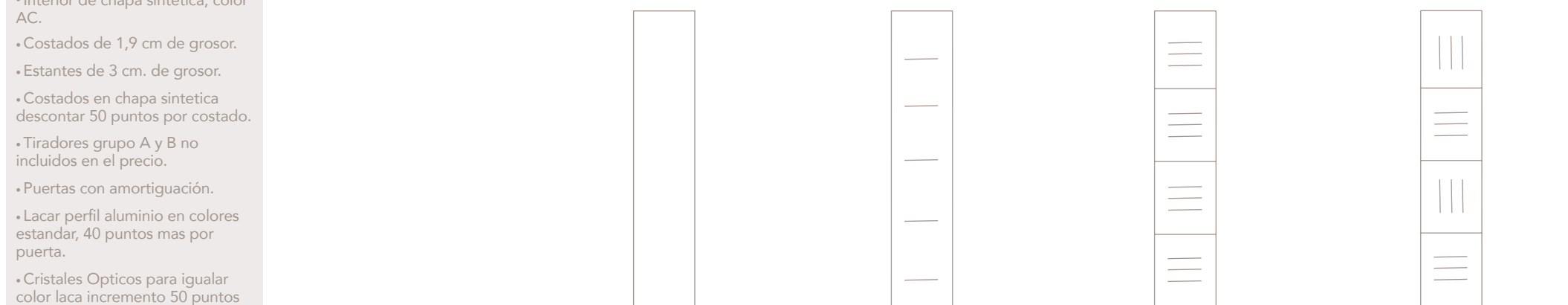
**NOTA.**

- Interior de chapa sintética, color AC.
- Costados de 1,9 cm de grosor.
- Estantes de 3 cm. de grosor.
- Costados en chapa sintética descontar 50 puntos por costado.
- Tiradores grupo A y B no incluidos en el precio.
- Puertas con amortiguación.
- Lacar perfil aluminio en colores estandar, 40 puntos mas por puerta.
- Cristales Opticos para igualar color laca incremento 50 puntos m².
- Cristales solapados mate opticos incremento 110 m².



Interiores	Sin Puerta	Puerta Lisa	Vetas Horizontales	Vetas Horizontales y rayas	Vetas cruzadas
 Ancho: 51,5 cm	<b>alto ref.</b> 242 80514 272 80525	<b>alto ref.</b> 242 80515 272 80526	<b>alto ref.</b> 242 80516 272 80527	<b>alto ref.</b> 242 80517 272 80528	<b>alto ref.</b> 242 80518 272 80529
 Ancho: 49,5 cm	<b>alto ref.</b> 242 80536 272 80547	<b>alto ref.</b> 242 80537 272 80548	<b>alto ref.</b> 242 80538 272 80549	<b>alto ref.</b> 242 80539 272 80550	<b>alto ref.</b> 242 80540 272 80551
<b>iz/dcha</b>  Ancho: 50 cm	<b>alto ref.</b> 242 80558 272 80569	<b>alto ref.</b> 242 80559 272 80570	<b>alto ref.</b> 242 80560 272 80571	<b>alto ref.</b> 242 80561 272 80572	<b>alto ref.</b> 242 80562 272 80573
<b>iz/dcha</b>  Ancho: 48 cm	<b>alto ref.</b> 242 80580 272 80591	<b>alto ref.</b> 242 80581 272 80592	<b>alto ref.</b> 242 80582 272 80593	<b>alto ref.</b> 242 80583 272 80594	<b>alto ref.</b> 242 80584 272 80595

## Armarios basicos rectos, combinación y chaflán • fondo 62 y 50 cm



Marco madera	Marco vidrio	Marco combinado	Marco trabas	Marco trabas y vidrio	Marco aluminio
<b>alto ref.</b> 242 80519 272 80530	<b>alto ref.</b> 242 80520 272 80531	<b>alto ref.</b> 242 80521 272 80532	<b>alto ref.</b> 242 80522 272 80533	<b>alto ref.</b> 242 80523 272 80534	<b>alto ref.</b> 242 80524 272 80535
<b>alto ref.</b> 242 80541 272 80552	<b>alto ref.</b> 242 80542 272 80553	<b>alto ref.</b> 242 80543 272 80554	<b>alto ref.</b> 242 80544 272 80555	<b>alto ref.</b> 242 80545 272 80556	<b>alto ref.</b> 242 80546 272 80557
<b>alto ref.</b> 242 80563 272 80574	<b>alto ref.</b> 242 80564 272 80575	<b>alto ref.</b> 242 80565 272 80576	<b>alto ref.</b> 242 80566 272 80577	<b>alto ref.</b> 242 80567 272 80578	<b>alto ref.</b> 242 80568 272 80579
<b>alto ref.</b> 242 80585 272 80596	<b>alto ref.</b> 242 80586 272 80597	<b>alto ref.</b> 242 80587 272 80598	<b>alto ref.</b> 242 80588 272 80599	<b>alto ref.</b> 242 80589 272 80560	<b>alto ref.</b> 242 80590 272 80561

## Armarios basicos rectos y rincón • fondo 62 y 50 cm

**NOTA.**

- Interior de chapa sintética, color AC.
- Costados de 1,9 cm de grosor.
- Estantes de 3 cm. de grosor.
- Costados en chapa sintética descontar 50 puntos por costado.
- Tiradores grupo A y B no incluidos en el precio.
- Puertas con amortiguación.
- Lacar perfil aluminio en colores estandar, 40 puntos mas por puerta.
- Cristales Opticos para igualar color laca incremento 50 puntos m<sup>2</sup>.
- Cristales solapados mate opticos incremento 110 m<sup>2</sup>.



Interiores	Sin Puerta	Puerta Lisa	Vetas Horizontales	Vetas Horizontales y rayas	Vetas cruzadas																														
<p>Ancho: 51,5 cm</p> <p>Cajones vistos</p>	<table border="1"> <tr><th>alto</th><th>ref.</th></tr> <tr><td>242</td><td>80602</td></tr> <tr><td>272</td><td>80613</td></tr> </table>	alto	ref.	242	80602	272	80613	<table border="1"> <tr><th>alto</th><th>ref.</th></tr> <tr><td>242</td><td>80603</td></tr> <tr><td>272</td><td>80614</td></tr> </table>	alto	ref.	242	80603	272	80614	<table border="1"> <tr><th>alto</th><th>ref.</th></tr> <tr><td>242</td><td>80604</td></tr> <tr><td>272</td><td>80615</td></tr> </table>	alto	ref.	242	80604	272	80615	<table border="1"> <tr><th>alto</th><th>ref.</th></tr> <tr><td>242</td><td>80605</td></tr> <tr><td>272</td><td>80616</td></tr> </table>	alto	ref.	242	80605	272	80616	<table border="1"> <tr><th>alto</th><th>ref.</th></tr> <tr><td>242</td><td>80606</td></tr> <tr><td>272</td><td>80617</td></tr> </table>	alto	ref.	242	80606	272	80617
	alto	ref.																																	
242	80602																																		
272	80613																																		
alto	ref.																																		
242	80603																																		
272	80614																																		
alto	ref.																																		
242	80604																																		
272	80615																																		
alto	ref.																																		
242	80605																																		
272	80616																																		
alto	ref.																																		
242	80606																																		
272	80617																																		

<p><b>Nota.</b> Si va al lado de un armario, tiene que ir con dos costados.</p> <p>Ancho: 95x95 cm 1 puerta</p>	<table border="1"> <tr><th>alto</th><th>ref.</th></tr> <tr><td>242</td><td>80624</td></tr> <tr><td>272</td><td>80635</td></tr> </table>	alto	ref.	242	80624	272	80635	<table border="1"> <tr><th>alto</th><th>ref.</th></tr> <tr><td>242</td><td>80625</td></tr> <tr><td>272</td><td>80636</td></tr> </table>	alto	ref.	242	80625	272	80636	<table border="1"> <tr><th>alto</th><th>ref.</th></tr> <tr><td>242</td><td>80626</td></tr> <tr><td>272</td><td>80637</td></tr> </table>	alto	ref.	242	80626	272	80637	<table border="1"> <tr><th>alto</th><th>ref.</th></tr> <tr><td>242</td><td>80627</td></tr> <tr><td>272</td><td>80638</td></tr> </table>	alto	ref.	242	80627	272	80638	<table border="1"> <tr><th>alto</th><th>ref.</th></tr> <tr><td>242</td><td>80628</td></tr> <tr><td>272</td><td>80639</td></tr> </table>	alto	ref.	242	80628	272	80639
alto	ref.																																		
242	80624																																		
272	80635																																		
alto	ref.																																		
242	80625																																		
272	80636																																		
alto	ref.																																		
242	80626																																		
272	80637																																		
alto	ref.																																		
242	80627																																		
272	80638																																		
alto	ref.																																		
242	80628																																		
272	80639																																		

<p><b>Nota.</b> Interior solo con 2 estantes y 1 barra. Descontar 240 puntos.</p> <p>Ancho: 110x110 cm 2 puertas</p>	<table border="1"> <tr><th>alto</th><th>ref.</th></tr> <tr><td>242</td><td>80646</td></tr> <tr><td>272</td><td>80657</td></tr> </table>	alto	ref.	242	80646	272	80657	<table border="1"> <tr><th>alto</th><th>ref.</th></tr> <tr><td>242</td><td>80647</td></tr> <tr><td>272</td><td>80658</td></tr> </table>	alto	ref.	242	80647	272	80658	<table border="1"> <tr><th>alto</th><th>ref.</th></tr> <tr><td>242</td><td>80648</td></tr> <tr><td>272</td><td>80659</td></tr> </table>	alto	ref.	242	80648	272	80659	<table border="1"> <tr><th>alto</th><th>ref.</th></tr> <tr><td>242</td><td>80649</td></tr> <tr><td>272</td><td>80660</td></tr> </table>	alto	ref.	242	80649	272	80660	<table border="1"> <tr><th>alto</th><th>ref.</th></tr> <tr><td>242</td><td>80650</td></tr> <tr><td>272</td><td>80661</td></tr> </table>	alto	ref.	242	80650	272	80661
alto	ref.																																		
242	80646																																		
272	80657																																		
alto	ref.																																		
242	80647																																		
272	80658																																		
alto	ref.																																		
242	80648																																		
272	80659																																		
alto	ref.																																		
242	80649																																		
272	80660																																		
alto	ref.																																		
242	80650																																		
272	80661																																		

## Armarios basicos rectos y rincón • fondo 62 y 50 cm

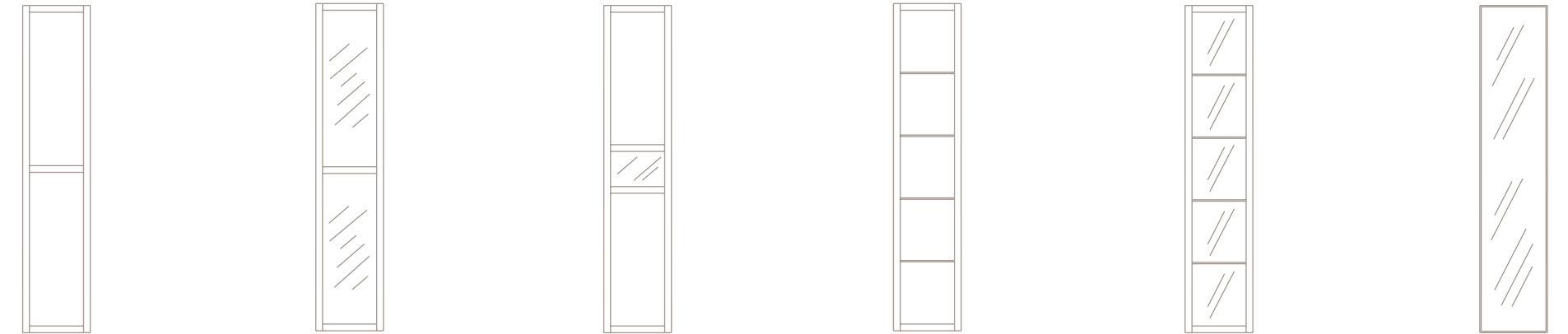

Marco madera	Marco vidrio	Marco combinado	Marco trabas	Marco trabas y vidrio	Marco aluminio																																				
<table border="1"> <tr><th>alto</th><th>ref.</th></tr> <tr><td>242</td><td>80607</td></tr> <tr><td>272</td><td>80618</td></tr> </table>	alto	ref.	242	80607	272	80618	<table border="1"> <tr><th>alto</th><th>ref.</th></tr> <tr><td>242</td><td>80608</td></tr> <tr><td>272</td><td>80619</td></tr> </table>	alto	ref.	242	80608	272	80619	<table border="1"> <tr><th>alto</th><th>ref.</th></tr> <tr><td>242</td><td>80609</td></tr> <tr><td>272</td><td>80620</td></tr> </table>	alto	ref.	242	80609	272	80620	<table border="1"> <tr><th>alto</th><th>ref.</th></tr> <tr><td>242</td><td>80610</td></tr> <tr><td>272</td><td>80621</td></tr> </table>	alto	ref.	242	80610	272	80621	<table border="1"> <tr><th>alto</th><th>ref.</th></tr> <tr><td>242</td><td>80611</td></tr> <tr><td>272</td><td>80622</td></tr> </table>	alto	ref.	242	80611	272	80622	<table border="1"> <tr><th>alto</th><th>ref.</th></tr> <tr><td>242</td><td>80612</td></tr> <tr><td>272</td><td>80623</td></tr> </table>	alto	ref.	242	80612	272	80623
alto	ref.																																								
242	80607																																								
272	80618																																								
alto	ref.																																								
242	80608																																								
272	80619																																								
alto	ref.																																								
242	80609																																								
272	80620																																								
alto	ref.																																								
242	80610																																								
272	80621																																								
alto	ref.																																								
242	80611																																								
272	80622																																								
alto	ref.																																								
242	80612																																								
272	80623																																								

<table border="1"> <tr><th>alto</th><th>ref.</th></tr> <tr><td>242</td><td>80629</td></tr> <tr><td>272</td><td>80640</td></tr> </table>	alto	ref.	242	80629	272	80640	<table border="1"> <tr><th>alto</th><th>ref.</th></tr> <tr><td>242</td><td>80630</td></tr> <tr><td>272</td><td>80641</td></tr> </table>	alto	ref.	242	80630	272	80641	<table border="1"> <tr><th>alto</th><th>ref.</th></tr> <tr><td>242</td><td>80631</td></tr> <tr><td>272</td><td>80642</td></tr> </table>	alto	ref.	242	80631	272	80642	<table border="1"> <tr><th>alto</th><th>ref.</th></tr> <tr><td>242</td><td>80632</td></tr> <tr><td>272</td><td>80643</td></tr> </table>	alto	ref.	242	80632	272	80643	<table border="1"> <tr><th>alto</th><th>ref.</th></tr> <tr><td>242</td><td>80633</td></tr> <tr><td>272</td><td>80644</td></tr> </table>	alto	ref.	242	80633	272	80644	<table border="1"> <tr><th>alto</th><th>ref.</th></tr> <tr><td>242</td><td>80634</td></tr> <tr><td>272</td><td>80645</td></tr> </table>	alto	ref.	242	80634	272	80645
alto	ref.																																								
242	80629																																								
272	80640																																								
alto	ref.																																								
242	80630																																								
272	80641																																								
alto	ref.																																								
242	80631																																								
272	80642																																								
alto	ref.																																								
242	80632																																								
272	80643																																								
alto	ref.																																								
242	80633																																								
272	80644																																								
alto	ref.																																								
242	80634																																								
272	80645																																								

<table border="1"> <tr><th>alto</th><th>ref.</th></tr> <tr><td>242</td><td>80651</td></tr> <tr><td>272</td><td>80662</td></tr> </table>	alto	ref.	242	80651	272	80662	<table border="1"> <tr><th>alto</th><th>ref.</th></tr> <tr><td>242</td><td>80652</td></tr> <tr><td>272</td><td>80663</td></tr> </table>	alto	ref.	242	80652	272	80663	<table border="1"> <tr><th>alto</th><th>ref.</th></tr> <tr><td>242</td><td>80653</td></tr> <tr><td>272</td><td>80664</td></tr> </table>	alto	ref.	242	80653	272	80664	<table border="1"> <tr><th>alto</th><th>ref.</th></tr> <tr><td>242</td><td>80654</td></tr> <tr><td>272</td><td>80665</td></tr> </table>	alto	ref.	242	80654	272	80665	<table border="1"> <tr><th>alto</th><th>ref.</th></tr> <tr><td>242</td><td>80655</td></tr> <tr><td>272</td><td>80666</td></tr> </table>	alto	ref.	242	80655	272	80666	<table border="1"> <tr><th>alto</th><th>ref.</th></tr> <tr><td>242</td><td>80656</td></tr> <tr><td>272</td><td>80667</td></tr> </table>	alto	ref.	242	80656	272	80667
alto	ref.																																								
242	80651																																								
272	80662																																								
alto	ref.																																								
242	80652																																								
272	80663																																								
alto	ref.																																								
242	80653																																								
272	80664																																								
alto	ref.																																								
242	80654																																								
272	80665																																								
alto	ref.																																								
242	80655																																								
272	80666																																								
alto	ref.																																								
242	80656																																								
272	80667																																								



## Armarios combinación rectos y chaflán • fondo 62 y 50 cm

**NOTA.**

- Interior de chapa sintética, color AC.
- Costados de 1,9 cm de grosor.
- Estantes de 3 cm. de grosor.
- Costados en chapa sintética descontar 50 puntos por costado.
- Tiradores grupo A y B no incluidos en el precio.
- Puertas con amortiguación.
- Laca perfil aluminio en colores estandar, 40 puntos mas por puerta.
- Cristales Opticos para igualar color laca incremento 50 puntos m<sup>2</sup>.
- Cristales solapados mate opticos incremento 110 m<sup>2</sup>.

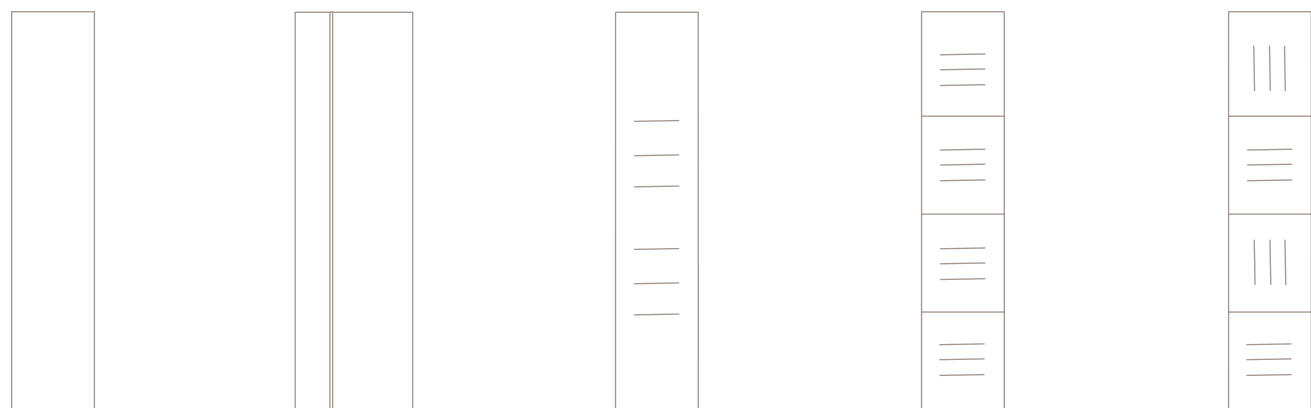

Interiores	Sin Puerta	Puerta Lisa	Puerta Seven	Vetas Horizontales	Vetas Horizontales y rayas	Vetas cruzadas
	<b>alto ref.</b> 242 80668 272 80680	<b>alto ref.</b> 242 80669 272 80681	<b>alto ref.</b> 242 80670 272 80682	<b>alto ref.</b> 242 80671 272 80683	<b>alto ref.</b> 242 80672 272 80684	<b>alto ref.</b> 242 80673 272 80685
	<b>alto ref.</b> 242 80692 272 80704	<b>alto ref.</b> 242 80693 272 80705	<b>alto ref.</b> 242 80694 272 80706	<b>alto ref.</b> 242 80695 272 80707	<b>alto ref.</b> 242 80696 272 80708	<b>alto ref.</b> 242 80697 272 80709
iz/dcha 	<b>alto ref.</b> 242 80716 272 80728	<b>alto ref.</b> 242 80717 272 80729	<b>alto ref.</b> 242 80718 272 80730	<b>alto ref.</b> 242 80719 272 80731	<b>alto ref.</b> 242 80720 272 80732	<b>alto ref.</b> 242 80721 272 80733
iz/dcha 	<b>alto ref.</b> 242 80740 272 80752	<b>alto ref.</b> 242 80741 272 80753	<b>alto ref.</b> 242 80742 272 80754	<b>alto ref.</b> 242 80743 272 80755	<b>alto ref.</b> 242 80744 272 80756	<b>alto ref.</b> 242 80745 272 80757

## Armarios combinación rectos y chaflán • fondo 62 y 50 cm



Marco madera	Marco vidrio	Marco combinado	Marco trabas	Marco trabas y vidrio	Marco aluminio
<b>alto ref.</b> 242 80674 272 80686	<b>alto ref.</b> 242 80675 272 80687	<b>alto ref.</b> 242 80676 272 80688	<b>alto ref.</b> 242 80677 272 80689	<b>alto ref.</b> 242 80678 272 80690	<b>alto ref.</b> 242 80679 272 80691
<b>alto ref.</b> 242 80698 272 80710	<b>alto ref.</b> 242 80699 272 80711	<b>alto ref.</b> 242 80700 272 80712	<b>alto ref.</b> 242 80701 272 80713	<b>alto ref.</b> 242 80702 272 80714	<b>alto ref.</b> 242 80703 272 80715
<b>alto ref.</b> 242 80722 272 80734	<b>alto ref.</b> 242 80723 272 80735	<b>alto ref.</b> 242 80724 272 80736	<b>alto ref.</b> 242 80725 272 80737	<b>alto ref.</b> 242 80726 272 80738	<b>alto ref.</b> 242 80727 272 80739
<b>alto ref.</b> 242 80746 272 80758	<b>alto ref.</b> 242 80747 272 80759	<b>alto ref.</b> 242 80748 272 80760	<b>alto ref.</b> 242 80749 272 80761	<b>alto ref.</b> 242 80750 272 80762	<b>alto ref.</b> 242 80751 272 80762

## Armarios rectos • fondo 62 cm

**NOTA.**

- Interior de chapa sintética, color AC.
- Costados de 1,9 cm de grosor.
- Estantes de 3 cm. de grosor.
- Costados en chapa sintética descontar 50 puntos por costado.
- Tiradores grupo A y B no incluidos en el precio.
- Puertas con amortiguación.
- Laca perfil aluminio en colores estandar, 40 puntos mas por puerta.
- Cristales Opticos para igualar color laca incremento 50 puntos m<sup>2</sup>.
- Cristales solapados mate opticos incremento 110 m<sup>2</sup>.

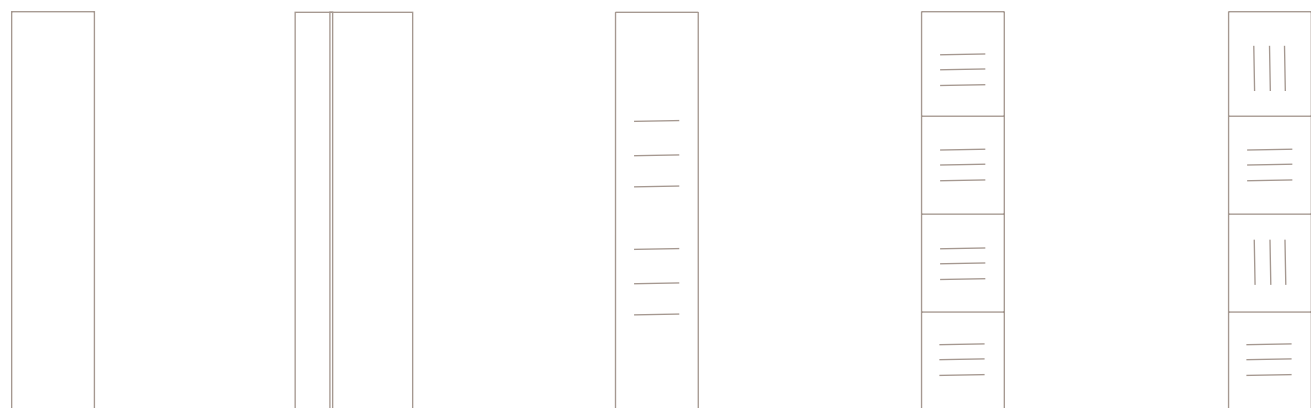

Interiores	Sin Puerta	Puerta Lisa	Puerta Seven	Vetas Horizontales	Vetas Horizontales y rayas	Vetas cruzadas
	<b>alto ref.</b> 242 80764 272 80776	<b>alto ref.</b> 242 80765 272 80777	<b>alto ref.</b> 242 80766 272 80778	<b>alto ref.</b> 242 80767 272 80779	<b>alto ref.</b> 242 80768 272 80780	<b>alto ref.</b> 242 80769 272 80781

Ancho: 149,5 cm

	<b>alto ref.</b> 242 80788 272 80800	<b>alto ref.</b> 242 80789 272 80801	<b>alto ref.</b> 242 80790 272 80802	<b>alto ref.</b> 242 80791 272 80803	<b>alto ref.</b> 242 80792 272 80804	<b>alto ref.</b> 242 80793 272 80805
--	--	--	--	--	--	--

Ancho: 198 cm

	<b>alto ref.</b> 242 80812 272 80824	<b>alto ref.</b> 242 80813 272 80825	<b>alto ref.</b> 242 80814 272 80826	<b>alto ref.</b> 242 80815 272 80827	<b>alto ref.</b> 242 80816 272 80828	<b>alto ref.</b> 242 80817 272 80829
--	--	--	--	--	--	--

Cajones vistos  
Ancho: 247,5 cm

## Armarios rectos • fondo 62 cm



Marco madera	Marco vidrio	Marco combinado	Marco trabas	Marco trabas y vidrio	Marco aluminio
<b>alto ref.</b> 242 80770 272 80782	<b>alto ref.</b> 242 80771 272 80783	<b>alto ref.</b> 242 80772 272 80784	<b>alto ref.</b> 242 80773 272 80785	<b>alto ref.</b> 242 80774 272 80786	<b>alto ref.</b> 242 80775 272 80787

<b>alto ref.</b> 242 80794 272 80806	<b>alto ref.</b> 242 80795 272 80807	<b>alto ref.</b> 242 80796 272 80808	<b>alto ref.</b> 242 80797 272 80809	<b>alto ref.</b> 242 80798 272 80810	<b>alto ref.</b> 242 80799 272 80811
--	--	--	--	--	--

<b>alto ref.</b> 242 80818 272 80830	<b>alto ref.</b> 242 80819 272 80831	<b>alto ref.</b> 242 80820 272 80832	<b>alto ref.</b> 242 80821 272 80833	<b>alto ref.</b> 242 80822 272 80834	<b>alto ref.</b> 242 80823 272 80835
--	--	--	--	--	--

## Armarios rectos • fondo 62 cm

**NOTA.**

- Interior de chapa sintética, color AC.
- Costados de 1,9 cm de grosor.
- Estantes de 3 cm. de grosor.
- Costados en chapa sintética descontar 50 puntos por costado.
- Tiradores grupo A y B no incluidos en el precio.
- Puertas con amortiguación.
- Lacar perfil aluminio en colores estandar, 40 puntos mas por puerta.
- Cristales Opticos para igualar color laca incremento 50 puntos m<sup>2</sup>.
- Cristales solapados mate opticos incremento 110 m<sup>2</sup>.

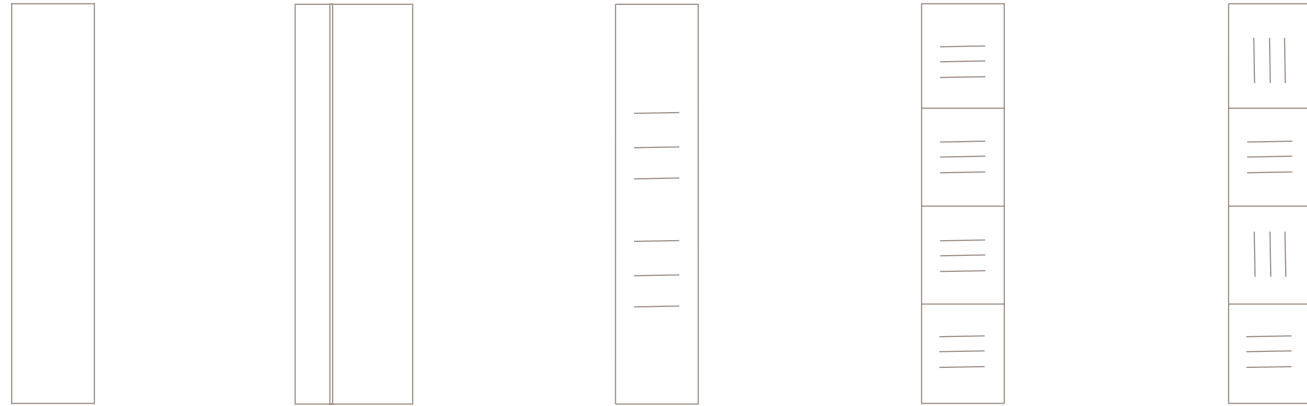

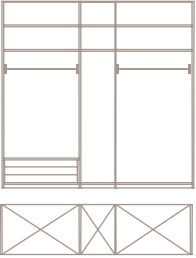
Interiores	Sin Puerta	Puerta Lisa	Puerta Seven	Vetas Horizontales	Vetas Horizontales y rayas	Vetas cruzadas
						
	<b>alto ref.</b> 242 80836 272 80848	<b>alto ref.</b> 242 80837 272 80849	<b>alto ref.</b> 242 80838 272 80850	<b>alto ref.</b> 242 80839 272 80851	<b>alto ref.</b> 242 80840 272 80852	<b>alto ref.</b> 242 80841 272 80853

Ancho: 247,5 cm

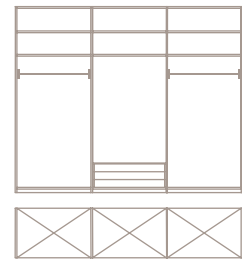

Ancho: 296 cm

<b>alto ref.</b> 242 80860 272 80872	<b>alto ref.</b> 242 80861 272 80873	<b>alto ref.</b> 242 80862 272 80874	<b>alto ref.</b> 242 80863 272 80875	<b>alto ref.</b> 242 80864 272 80876	<b>alto ref.</b> 242 80865 272 80877
--	--	--	--	--	--

## Armarios rectos • fondo 62 cm

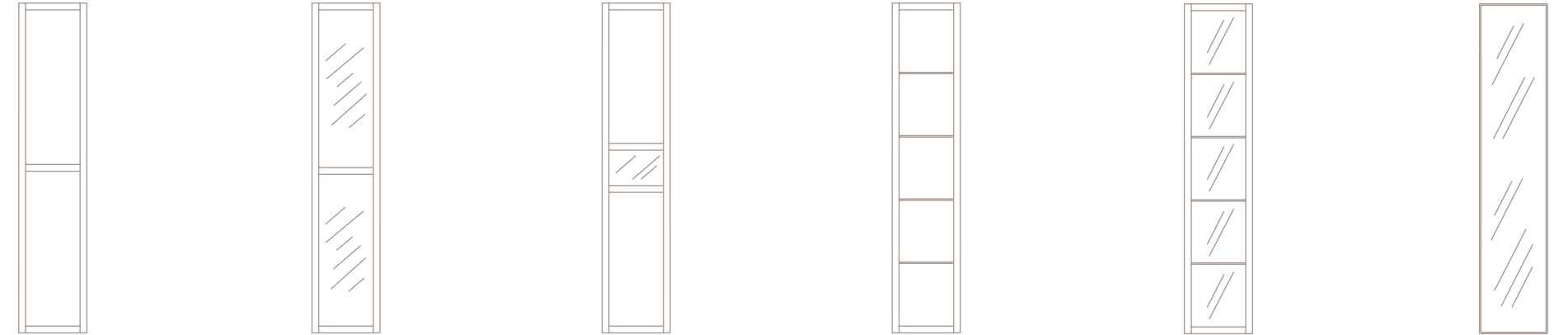

Marco madera	Marco vidrio	Marco combinado	Marco trabas	Marco trabas y vidrio	Marco aluminio
<b>alto ref.</b> 242 80842 272 80854	<b>alto ref.</b> 242 80843 272 80855	<b>alto ref.</b> 242 80844 272 80856	<b>alto ref.</b> 242 80845 272 80857	<b>alto ref.</b> 242 80846 272 80858	<b>alto ref.</b> 242 80847 272 80859

<b>alto ref.</b> 242 80866 272 80878	<b>alto ref.</b> 242 80867 272 80879	<b>alto ref.</b> 242 80868 272 80880	<b>alto ref.</b> 242 80869 272 80881	<b>alto ref.</b> 242 80870 272 80882	<b>alto ref.</b> 242 80871 272 80883
--	--	--	--	--	--

## Armarios puertas plegables • fondo 62 cm

**NOTA.**

- Interior de chapa sintética, color AC.
- Costados de 1,9 cm de grosor.
- Estantes de 3 cm de grosor.
- Costados en chapa sintética descontar 50 puntos por costado.
- Tiradores grupo A y B no incluidos en el precio.
- Puertas con amortiguación.
- Cristales ópticos para igualar color laca incremento 50 puntos por m<sup>2</sup>.
- Cristales solapados mate ópticos, incremento 110 puntos por m<sup>2</sup>.

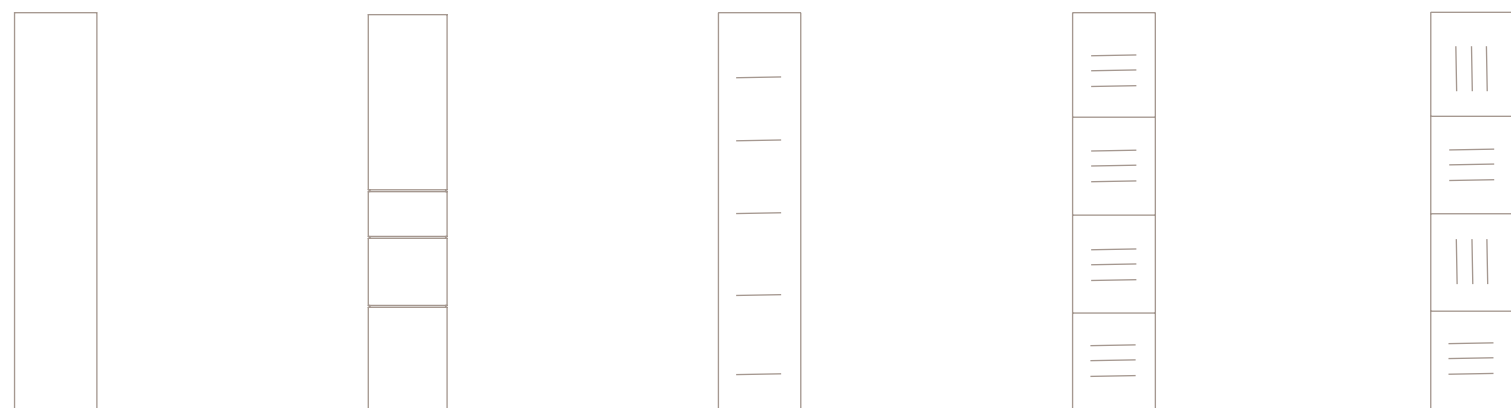

Interiores	Puerta Lisa	Puerta Ray	Vetas Horizontales	Vetas Horizontales y rayas	Vetas cruzadas
------------	-------------	------------	--------------------	----------------------------	----------------



2 puertas plegables de 100 cm

alto	ref.	alto	ref.	alto	ref.	alto	ref.	alto	ref.	alto	ref.
242	N-83000	242	N-83001	242	N-83002	242	N-83003	242	N-83004	242	N-83005
272	N-83011	272	N-83012	272	N-83013	272	N-83014	272	N-83015		

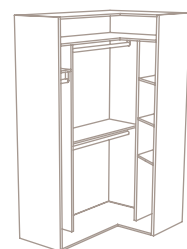

Rinconero plegable 110 x 160 cm

alto	ref.	alto	ref.	alto	ref.	alto	ref.	alto	ref.	alto	ref.
242	N-83066	242	N-83067	242	N-83068	242	N-83069	242	N-83070	242	N-83071
272	N-83077	272	N-83078	272	N-83079	272	N-83080	272	N-83081		

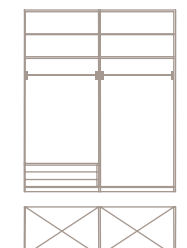

4 puertas plegables 198 cm

alto	ref.	alto	ref.	alto	ref.	alto	ref.	alto	ref.	alto	ref.
242	N-83044	242	N-83045	242	N-83046	242	N-83047	242	N-83048	242	N-83049
272	N-83055	272	N-83056	272	N-83057	272	N-83058	272	N-83059		

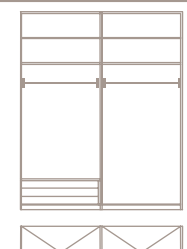

4 puertas plegables 240 cm

alto	ref.	alto	ref.	alto	ref.	alto	ref.	alto	ref.	alto	ref.
242	N-84000	242	N-84001	242	N-84002	242	N-84003	242	N-84004	242	N-84005
272	N-84011	272	N-84012	272	N-84013	272	N-84014	272	N-84015		

## Armarios puertas plegables • fondo 62 cm

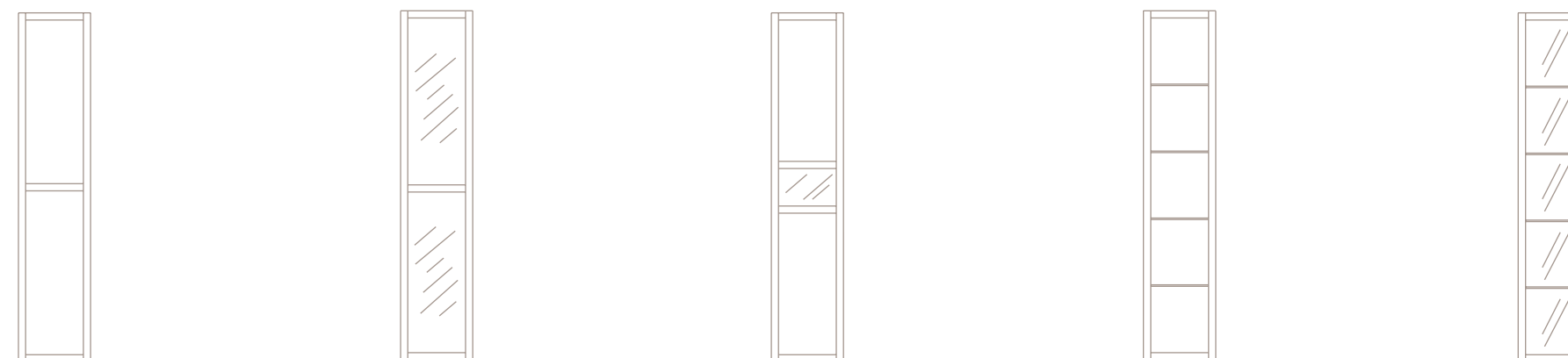

Marco madera	Marco vidrio	Marco combinado	Marco trabas	Marco trabas y vidrio
--------------	--------------	-----------------	--------------	-----------------------

alto	ref.	alto	ref.	alto	ref.	alto	ref.	alto	ref.
242	N-83005	242	N-83006	242	N-83007	242	N-83008	242	N-83009
272	N-83016	272	N-83017	272	N-83018	272	N-83019	272	N-83020

alto	ref.	alto	ref.	alto	ref.	alto	ref.	alto	ref.
242	N-83071	242	N-83072	242	N-83073	242	N-83074	242	N-83075
272	N-83082	272	N-83083	272	N-83084	272	N-83085	272	N-83086

alto	ref.	alto	ref.	alto	ref.	alto	ref.	alto	ref.
242	N-83049	242	N-83050	242	N-83051	242	N-83052	242	N-83053
272	N-83060	272	N-83061	272	N-83062	272	N-83063	272	N-83064

alto	ref.	alto	ref.	alto	ref.	alto	ref.	alto	ref.
242	N-84005	242	N-84006	242	N-84007	242	N-84008	242	N-84009
272	N-84016	272	N-84017	272	N-84018	272	N-84019	272	N-84020

## Armario puerta plegable • fondo 62 cm • con 3 huecos desiguales

**NOTA.**

- Interior de chapa sintética, color AC.
- Costados de 1,9 cm de grosor.
- Estantes de 3 cm de grosor.
- Costados en chapa sintética descontar 50 puntos por costado.
- Tiradores grupo A y B no incluidos en el precio.
- Puertas con amortiguación.
- Cristales ópticos para igualar color laca incremento 50 puntos por m<sup>2</sup>.
- Cristales solapados mate ópticos, incremento 110 puntos por m<sup>2</sup>.

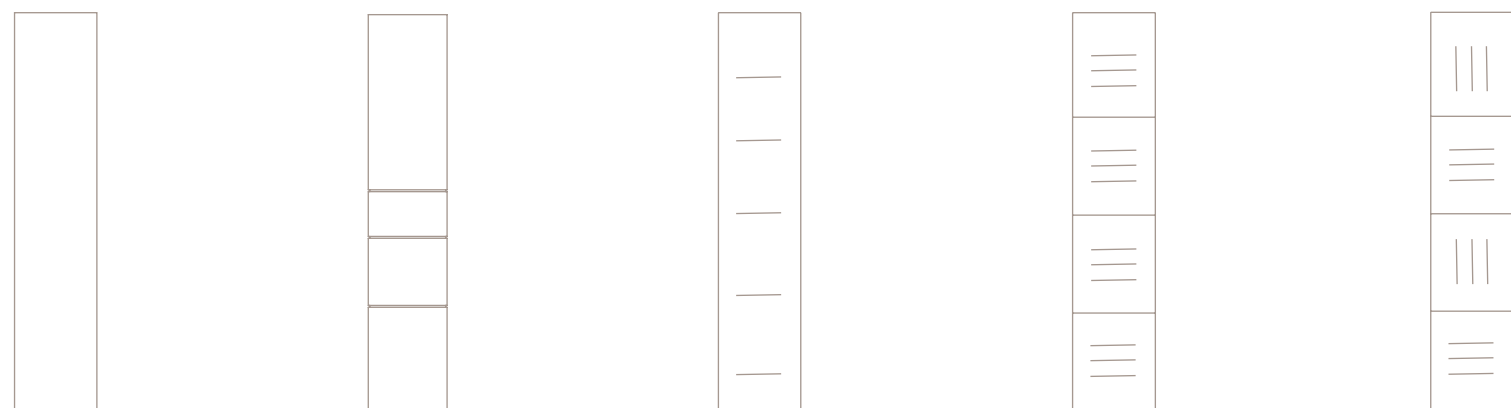

Interiores	Puerta Lisa	Puerta Ray	Vetas Horizontales	Vetas Horizontales y rayas	Vetas cruzadas																														
<p>4 puertas plegables, huecos desiguales, 198 cm</p>	<table border="1"> <tr><th>alto</th><th>ref.</th></tr> <tr><td>242</td><td>N-84021</td></tr> <tr><td>272</td><td>N-84032</td></tr> </table>	alto	ref.	242	N-84021	272	N-84032	<table border="1"> <tr><th>alto</th><th>ref.</th></tr> <tr><td>242</td><td>N-84022</td></tr> <tr><td>272</td><td>N-84033</td></tr> </table>	alto	ref.	242	N-84022	272	N-84033	<table border="1"> <tr><th>alto</th><th>ref.</th></tr> <tr><td>242</td><td>N-84023</td></tr> <tr><td>272</td><td>N-84034</td></tr> </table>	alto	ref.	242	N-84023	272	N-84034	<table border="1"> <tr><th>alto</th><th>ref.</th></tr> <tr><td>242</td><td>N-84024</td></tr> <tr><td>272</td><td>N-84035</td></tr> </table>	alto	ref.	242	N-84024	272	N-84035	<table border="1"> <tr><th>alto</th><th>ref.</th></tr> <tr><td>242</td><td>N-84025</td></tr> <tr><td>272</td><td>N-84036</td></tr> </table>	alto	ref.	242	N-84025	272	N-84036
	alto	ref.																																	
242	N-84021																																		
272	N-84032																																		
alto	ref.																																		
242	N-84022																																		
272	N-84033																																		
alto	ref.																																		
242	N-84023																																		
272	N-84034																																		
alto	ref.																																		
242	N-84024																																		
272	N-84035																																		
alto	ref.																																		
242	N-84025																																		
272	N-84036																																		

<p>4 puertas plegables, huecos desiguales, 240 cm</p>	<table border="1"> <tr><th>alto</th><th>ref.</th></tr> <tr><td>242</td><td>N-84042</td></tr> <tr><td>272</td><td>N-84053</td></tr> </table>	alto	ref.	242	N-84042	272	N-84053	<table border="1"> <tr><th>alto</th><th>ref.</th></tr> <tr><td>242</td><td>N-84043</td></tr> <tr><td>272</td><td>N-84054</td></tr> </table>	alto	ref.	242	N-84043	272	N-84054	<table border="1"> <tr><th>alto</th><th>ref.</th></tr> <tr><td>242</td><td>N-84044</td></tr> <tr><td>272</td><td>N-84055</td></tr> </table>	alto	ref.	242	N-84044	272	N-84055	<table border="1"> <tr><th>alto</th><th>ref.</th></tr> <tr><td>242</td><td>N-84045</td></tr> <tr><td>272</td><td>N-84056</td></tr> </table>	alto	ref.	242	N-84045	272	N-84056	<table border="1"> <tr><th>alto</th><th>ref.</th></tr> <tr><td>242</td><td>N-84046</td></tr> <tr><td>272</td><td>N-84057</td></tr> </table>	alto	ref.	242	N-84046	272	N-84057
	alto	ref.																																	
242	N-84042																																		
272	N-84053																																		
alto	ref.																																		
242	N-84043																																		
272	N-84054																																		
alto	ref.																																		
242	N-84044																																		
272	N-84055																																		
alto	ref.																																		
242	N-84045																																		
272	N-84056																																		
alto	ref.																																		
242	N-84046																																		
272	N-84057																																		

## Armario puerta plegable • fondo 62 cm • interior vestidor

<p>4 puertas plegables, interior vestidor, 198 cm</p>	<table border="1"> <tr><th>alto</th><th>ref.</th></tr> <tr><td>242</td><td>N-84063</td></tr> <tr><td>272</td><td>N-84074</td></tr> </table>	alto	ref.	242	N-84063	272	N-84074	<table border="1"> <tr><th>alto</th><th>ref.</th></tr> <tr><td>242</td><td>N-84064</td></tr> <tr><td>272</td><td>N-84075</td></tr> </table>	alto	ref.	242	N-84064	272	N-84075	<table border="1"> <tr><th>alto</th><th>ref.</th></tr> <tr><td>242</td><td>N-84065</td></tr> <tr><td>272</td><td>N-84076</td></tr> </table>	alto	ref.	242	N-84065	272	N-84076	<table border="1"> <tr><th>alto</th><th>ref.</th></tr> <tr><td>242</td><td>N-84066</td></tr> <tr><td>272</td><td>N-84077</td></tr> </table>	alto	ref.	242	N-84066	272	N-84077	<table border="1"> <tr><th>alto</th><th>ref.</th></tr> <tr><td>242</td><td>N-84067</td></tr> <tr><td>272</td><td>N-84078</td></tr> </table>	alto	ref.	242	N-84067	272	N-84078
	alto	ref.																																	
242	N-84063																																		
272	N-84074																																		
alto	ref.																																		
242	N-84064																																		
272	N-84075																																		
alto	ref.																																		
242	N-84065																																		
272	N-84076																																		
alto	ref.																																		
242	N-84066																																		
272	N-84077																																		
alto	ref.																																		
242	N-84067																																		
272	N-84078																																		

<p>4 puertas plegables, interior vestidor, 240 cm</p>	<table border="1"> <tr><th>alto</th><th>ref.</th></tr> <tr><td>242</td><td>N-84084</td></tr> <tr><td>272</td><td>N-84095</td></tr> </table>	alto	ref.	242	N-84084	272	N-84095	<table border="1"> <tr><th>alto</th><th>ref.</th></tr> <tr><td>242</td><td>N-84085</td></tr> <tr><td>272</td><td>N-84096</td></tr> </table>	alto	ref.	242	N-84085	272	N-84096	<table border="1"> <tr><th>alto</th><th>ref.</th></tr> <tr><td>242</td><td>N-84086</td></tr> <tr><td>272</td><td>N-84097</td></tr> </table>	alto	ref.	242	N-84086	272	N-84097	<table border="1"> <tr><th>alto</th><th>ref.</th></tr> <tr><td>242</td><td>N-84087</td></tr> <tr><td>272</td><td>N-84098</td></tr> </table>	alto	ref.	242	N-84087	272	N-84098	<table border="1"> <tr><th>alto</th><th>ref.</th></tr> <tr><td>242</td><td>N-84088</td></tr> <tr><td>272</td><td>N-84099</td></tr> </table>	alto	ref.	242	N-84088	272	N-84099
	alto	ref.																																	
242	N-84084																																		
272	N-84095																																		
alto	ref.																																		
242	N-84085																																		
272	N-84096																																		
alto	ref.																																		
242	N-84086																																		
272	N-84097																																		
alto	ref.																																		
242	N-84087																																		
272	N-84098																																		
alto	ref.																																		
242	N-84088																																		
272	N-84099																																		

## Armario puerta plegable • fondo 62 cm • con 3 huecos desiguales

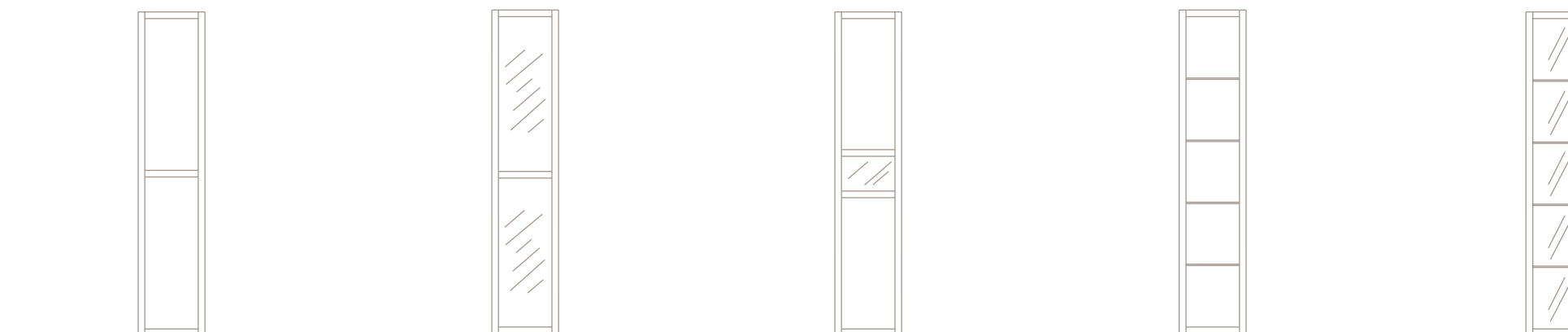

Marco madera	Marco vidrio	Marco combinado	Marco trabas	Marco trabas y vidrio																														
<table border="1"> <tr><th>alto</th><th>ref.</th></tr> <tr><td>242</td><td>N-84026</td></tr> <tr><td>272</td><td>N-84037</td></tr> </table>	alto	ref.	242	N-84026	272	N-84037	<table border="1"> <tr><th>alto</th><th>ref.</th></tr> <tr><td>242</td><td>N-84027</td></tr> <tr><td>272</td><td>N-84038</td></tr> </table>	alto	ref.	242	N-84027	272	N-84038	<table border="1"> <tr><th>alto</th><th>ref.</th></tr> <tr><td>242</td><td>N-84028</td></tr> <tr><td>272</td><td>N-84039</td></tr> </table>	alto	ref.	242	N-84028	272	N-84039	<table border="1"> <tr><th>alto</th><th>ref.</th></tr> <tr><td>242</td><td>N-84029</td></tr> <tr><td>272</td><td>N-84040</td></tr> </table>	alto	ref.	242	N-84029	272	N-84040	<table border="1"> <tr><th>alto</th><th>ref.</th></tr> <tr><td>242</td><td>N-84030</td></tr> <tr><td>272</td><td>N-84041</td></tr> </table>	alto	ref.	242	N-84030	272	N-84041
alto	ref.																																	
242	N-84026																																	
272	N-84037																																	
alto	ref.																																	
242	N-84027																																	
272	N-84038																																	
alto	ref.																																	
242	N-84028																																	
272	N-84039																																	
alto	ref.																																	
242	N-84029																																	
272	N-84040																																	
alto	ref.																																	
242	N-84030																																	
272	N-84041																																	

<table border="1"> <tr><th>alto</th><th>ref.</th></tr> <tr><td>242</td><td>N-84047</td></tr> <tr><td>272</td><td>N-84058</td></tr> </table>	alto	ref.	242	N-84047	272	N-84058	<table border="1"> <tr><th>alto</th><th>ref.</th></tr> <tr><td>242</td><td>N-84048</td></tr> <tr><td>272</td><td>N-84059</td></tr> </table>	alto	ref.	242	N-84048	272	N-84059	<table border="1"> <tr><th>alto</th><th>ref.</th></tr> <tr><td>242</td><td>N-84049</td></tr> <tr><td>272</td><td>N-84060</td></tr> </table>	alto	ref.	242	N-84049	272	N-84060	<table border="1"> <tr><th>alto</th><th>ref.</th></tr> <tr><td>242</td><td>N-84050</td></tr> <tr><td>272</td><td>N-84061</td></tr> </table>	alto	ref.	242	N-84050	272	N-84061	<table border="1"> <tr><th>alto</th><th>ref.</th></tr> <tr><td>242</td><td>N-84051</td></tr> <tr><td>272</td><td>N-84062</td></tr> </table>	alto	ref.	242	N-84051	272	N-84062
alto	ref.																																	
242	N-84047																																	
272	N-84058																																	
alto	ref.																																	
242	N-84048																																	
272	N-84059																																	
alto	ref.																																	
242	N-84049																																	
272	N-84060																																	
alto	ref.																																	
242	N-84050																																	
272	N-84061																																	
alto	ref.																																	
242	N-84051																																	
272	N-84062																																	

## Armario puerta plegable • fondo 62 cm • interior vestidor

<table border="1"> <tr><th>alto</th><th>ref.</th></tr> <tr><td>242</td><td>N-84068</td></tr> <tr><td>272</td><td>N-84079</td></tr> </table>	alto	ref.	242	N-84068	272	N-84079	<table border="1"> <tr><th>alto</th><th>ref.</th></tr> <tr><td>242</td><td>N-84069</td></tr> <tr><td>272</td><td>N-84080</td></tr> </table>	alto	ref.	242	N-84069	272	N-84080	<table border="1"> <tr><th>alto</th><th>ref.</th></tr> <tr><td>242</td><td>N-84070</td></tr> <tr><td>272</td><td>N-84081</td></tr> </table>	alto	ref.	242	N-84070	272	N-84081	<table border="1"> <tr><th>alto</th><th>ref.</th></tr> <tr><td>242</td><td>N-84071</td></tr> <tr><td>272</td><td>N-84082</td></tr> </table>	alto	ref.	242	N-84071	272	N-84082	<table border="1"> <tr><th>alto</th><th>ref.</th></tr> <tr><td>242</td><td>N-84072</td></tr> <tr><td>272</td><td>N-84083</td></tr> </table>	alto	ref.	242	N-84072	272	N-84083
alto	ref.																																	
242	N-84068																																	
272	N-84079																																	
alto	ref.																																	
242	N-84069																																	
272	N-84080																																	
alto	ref.																																	
242	N-84070																																	
272	N-84081																																	
alto	ref.																																	
242	N-84071																																	
272	N-84082																																	
alto	ref.																																	
242	N-84072																																	
272	N-84083																																	

<table border="1"> <tr><th>alto</th><th>ref.</th></tr> <tr><td>242</td><td>N-84089</td></tr> <tr><td>272</td><td>N-84100</td></tr> </table>	alto	ref.	242	N-84089	272	N-84100	<table border="1"> <tr><th>alto</th><th>ref.</th></tr> <tr><td>242</td><td>N-84090</td></tr> <tr><td>272</td><td>N-84101</td></tr> </table>	alto	ref.	242	N-84090	272	N-84101	<table border="1"> <tr><th>alto</th><th>ref.</th></tr> <tr><td>242</td><td>N-84091</td></tr> <tr><td>272</td><td>N-84102</td></tr> </table>	alto	ref.	242	N-84091	272	N-84102	<table border="1"> <tr><th>alto</th><th>ref.</th></tr> <tr><td>242</td><td>N-84092</td></tr> <tr><td>272</td><td>N-84103</td></tr> </table>	alto	ref.	242	N-84092	272	N-84103	<table border="1"> <tr><th>alto</th><th>ref.</th></tr> <tr><td>242</td><td>N-84093</td></tr> <tr><td>272</td><td>N-84104</td></tr> </table>	alto	ref.	242	N-84093	272	N-84104
alto	ref.																																	
242	N-84089																																	
272	N-84100																																	
alto	ref.																																	
242	N-84090																																	
272	N-84101																																	
alto	ref.																																	
242	N-84091																																	
272	N-84102																																	
alto	ref.																																	
242	N-84092																																	
272	N-84103																																	
alto	ref.																																	
242	N-84093																																	
272	N-84104																																	

## Armarios 2 puertas coplanares • fondo 63,5 cm

**NOTA.**

- Interior de chapa sintética, color AC.
- Costados en chapa sintética descontar 50 puntos por costado.
- Se debe restar un mínimo de 4 cm de alto a la altura del techo para poder colgar las puertas.
- Puertas de grueso 2,5 cm.

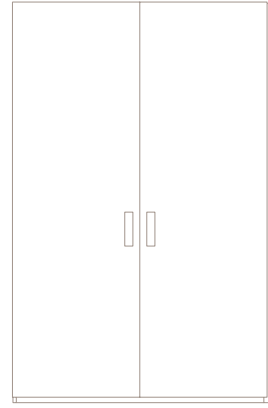

**Interiores**

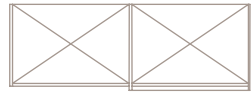
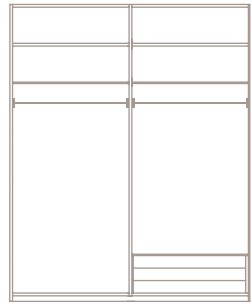

alto	ancho	ref.
242	166	N-85000
242	186	N-85001
242	206	N-85002
242	226	N-85003
242	246	N-85004
242	266	N-85005

alto	ancho	ref.
272	166	N-85021
272	186	N-85022
272	206	N-85023
272	226	N-85024
272	246	N-85025
272	266	N-85026

NOVO

## Armarios batientes perfil NOVO color Moka • fondo 63,5 cm

**NOTA.**

- Interior de chapa sintética, Besform.
- Costados de grueso 1,9 cm.
- Estantes de grueso 3 cm.
- Parsol gris, negro y bronce.
- Puertas de grueso 3,5 cm.



**Interiores**



Ancho:  
51,5 cm

alto	ref.
242	N-85200
272	N-85205



Ancho:  
49,5 cm

alto	ref.
242	N-85210
272	N-85215



Ancho:  
100 cm

alto	ref.
242	N-85220
272	N-85225



Ancho:  
98 cm

alto	ref.
242	N-85230
272	N-85235

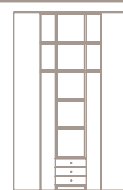

Ancho:  
110 x 110 cm

alto	ref.
242	N-85240
272	N-85245

**Nota.** Interior solo con 2 estantes y una barra descontar 240 puntos.



## Armarios batientes perfil NOVO color Moka • fondo 63,5 cm

**NOTA.**

- Interior de chapa sintética, Besform.
- Costados de grueso 1,9 cm.
- Estantes de grueso 3 cm.
- Parsol gris, negro y bronce.
- Puertas de grueso 3,5 cm.



**Interiores**

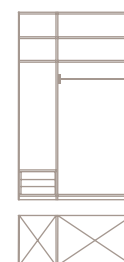

Ancho:  
149,5 cm

alto	ref.
242	N-85250
272	N-85255



Ancho:  
198 cm

alto	ref.
242	N-85260
272	N-85265

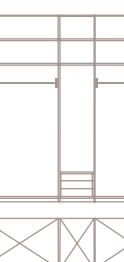

Ancho:  
247,5 cm

alto	ref.
242	N-85270
272	N-85275

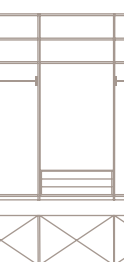

Ancho:  
296 cm

alto	ref.
242	N-85280
272	N-85285

## Complementos Moka Armarios

### BARRA CON SOPORTES LATERALES



ancho	referencia
50	N-85550
100	N-85501
125	N-85502

### SOPORTE CENTRAL PARA BARRA

referencia
N-85503

### BANDEJA MULTIFUNCIÓN EXTENSIBLE CON TAPAS

Para fondo 60 cm

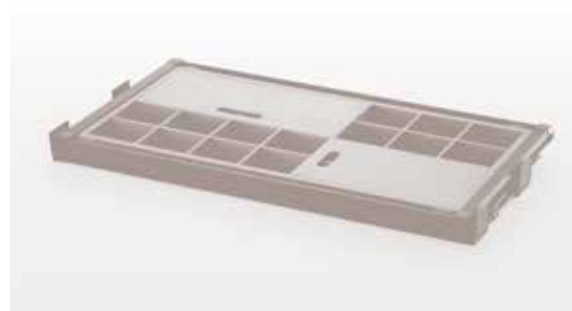

ancho	referencia
70	N-85510
80	N-85511
90	N-85512
100	N-85513

### BANDEJA MULTIFUNCIÓN EXTENSIBLE

Para fondo 60 cm



ancho	referencia
50	N-85524
60	N-85525
70	N-85526
80	N-85527
90	N-85528
100	N-85529

## Complementos Moka Armarios

### BANDEJA METÁLICA EXTENSIBLE

Para fondo 60 cm



ancho	referencia
50	N-85535
60	N-85536
70	N-85537
80	N-85538
90	N-85539
100	N-85540

### CESTA RATÁN EXTENSIBLE

Para fondo 60 cm



ancho	referencia
50	N-85550
60	N-85551
70	N-85552
80	N-85553
90	N-85554
100	N-85555

### PANTALONERO BARRAS

Para fondo 60 cm



ancho	referencia
50 - 5 barras	N-85560
60 - 6 barras	N-85561
70 - 7 barras	N-85562
80 - 8 barras	N-85563
90 - 9 barras	N-85564
100 - 10 barras	N-85565

### JUEGO VARILLAS PANTALONERO (4 UDS.)



referencia
N-85567



## Complementos Moka Armarios

### ZAPATERO CON BASE METÁLICA EXTENSIBLE

Para fondo 60 cm



ancho	referencia
50	N-85580
60	N-85581
70	N-85582
80	N-85583
90	N-85584
100	N-85585

### CORBATERO

Para fondo 60 cm



#### referencia

N-85589

### BARRA ABATIBLE MOKA



#### ancho referencia

80 -100 N-85590

### ESTANTE EXTRAIBLE

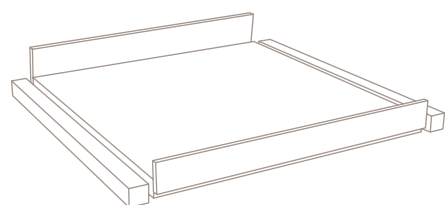

#### ancho referencia

47,5 N-85592  
75,5 N-85593  
95,5 N-85594

### ESTANTE INCLINADO CON FALDONES

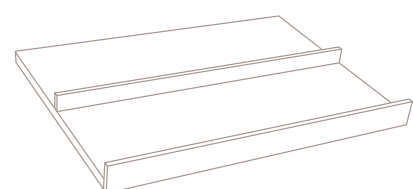

#### ancho referencia

47,5 N-85596  
75,5 N-85597  
95,5 N-85598  
115,5 N-85599

complementos  
armarios

## Complementos - Puertas plegables interior vestidor

### DIVISIONES INTERIORES ARMARIO · Fondo 30 cm



medidas	referencia
80x3x30	N-85600
180x3x30	N-85601
242x3x30	N-85602
272x3x30	N-85603

### ESTANTES INTERIORES DE ARMARIOS CON ENCAJE

estantes laterales



estantes centrales

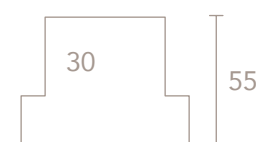

ancho	referencia
30	N-85610
45	N-85611
75	N-85612
95	N-85613
120	N-85614

### CAJONES INTERIOR ARMARIO + PANTALONERO FRENTE VISTA

1 cajón + 1 pantalonero

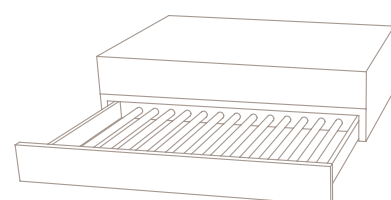

2 cajones + 1 pantalonero

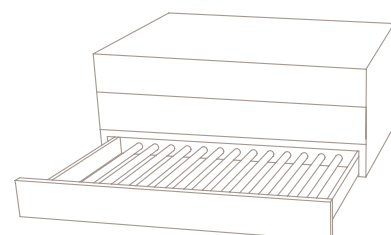

3 cajones + 1 pantalonero

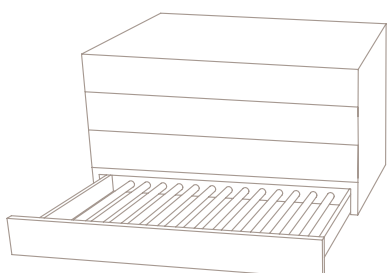

descripción	ancho	referencia
1 cajón + 1 pantalonero	50	N-85630
2 cajones + 1 pantalonero		N-85631
3 cajones + 1 pantalonero		N-85632

descripción	ancho	referencia
1 cajón + 1 pantalonero	75	N-85637
2 cajones + 1 pantalonero		N-85638
3 cajones + 1 pantalonero		N-85639

descripción	ancho	referencia
1 cajón + 1 pantalonero	100	N-85645
2 cajones + 1 pantalonero		N-85646
3 cajones + 1 pantalonero		N-85647

## Cajones interior Armarios · Fondo 45 y 55 cm.

### FRENTES MADERA

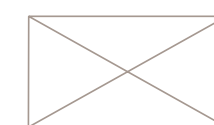
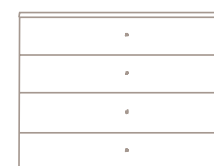

descripción	ancho	ref.	ancho	ref.	ancho	ref.
1 cajón altura 21	50	81001	75	81006	100	81011
2 cajones altura 36		81002		81007		81012
3 cajones altura 52		81003		81008		81013
4 cajones altura 76		81004		81009		81014
5 cajones altura 94		81005		81010		81015

### FRENTES VIDRIO

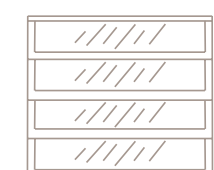

descripción	ancho	ref.	ancho	ref.	ancho	ref.
1 cajón altura 21	50	81020	75	81025	100	81030
2 cajones altura 36		81021		81026		81031
3 cajones altura 52		81022		81027		81032
4 cajones altura 76		81023		81028		81033
5 cajones altura 94		81024		81029		81034

### DIVISIONES INTERIORES ARMARIO

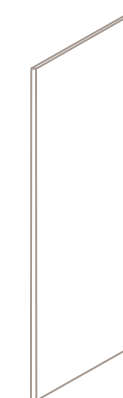

ancho	referencia
80 x 3 x 60	81036
180 x 3 x 60	81037
242 x 3 x 60	81038
272 x 3 x 60	81039

Interiores para todo tipo de armarios.

## Complementos para armarios

### BARRA CON SOPORTE LATERAL



Barra con soporte lateral		Soporte central para barra
ancho	referencia	referencia
45	11600	11613
75	11601	
105	11602	

### PANTALONERO EXTRAÍBLE CON CAJÓN

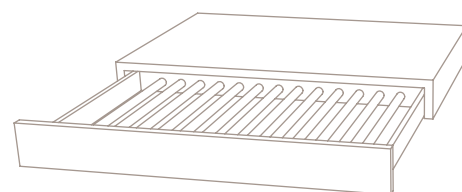

Melamina AC	
ancho	referencia
30	11624
45	11625
60	11626
75	11627
90	11628
105	11629

### CASILLERO PARA CAJÓN

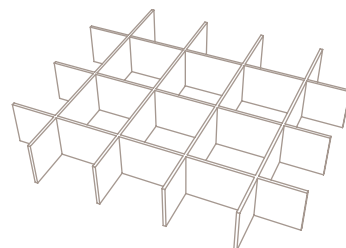

ancho	referencia
60	11642
75	11643
90	11644
105	11645

### ZAPATERO EXTRAÍBLE

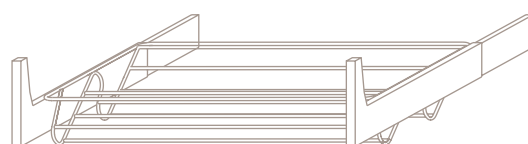

40 a 60	referencia
con tapa	80972
sin tapa	80973
60 a 100	referencia
con tapa	80974
sin tapa	80975

## Complementos para armarios

### BARRA ABATIBLE

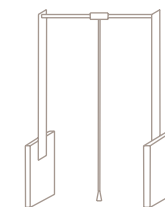

ancho	referencia
80 a 100	80978

### PANTALONERO EXTRAÍBLE

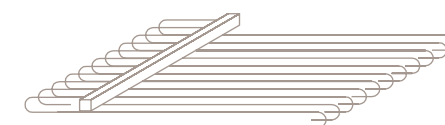

referencia
80980

11 pantalones.  
Fondo: 47 cm. Ancho :35 cm

### ESTANTE RINCÓN

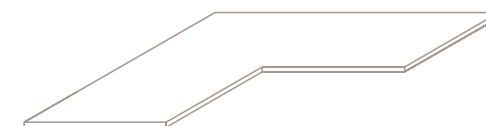

ancho	referencia
108	80987

Fondo: 108 x 108 cm  
Grueso: 3 cm

### ESTANTES EXTRAÍBLES ARMARIOS

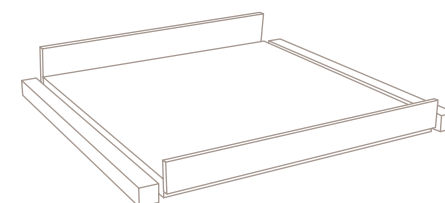

ancho	referencia
47,5	80996
75,5	80997
95,5	80998

Fondo: 55 y 46 cm  
Grueso: 3 cm

### ESTANTES INTERIORES ARMARIOS

Con led y sensor de movimiento

ancho	referencia
30	N-85710
45	N-85711
75	N-85712
95	N-85713
115	N-85714
135	N-85715

### BARRA PETACA

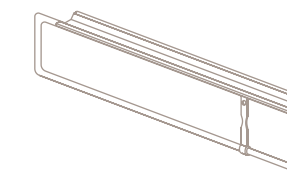

fondo	referencia
25 a 50	80979

### ESTANTES INTERIORES CHAFLÁN 46 Y 94,5 cm



ancho	referencia
45	80985
94,5	80986

Fondo: 55 y 45 cm  
Grueso: 3 cm

### ESTANTES INTERIORES ARMARIOS

ancho	referencia
47,5	80988
75,5	80989
95,5	80990
120,5	80991
135,5	80992
145,5	80993

Fondo: 55 cm  
Grueso: 3 cm

### ESTANTE INCLINADO CON FALDONES



ancho	referencia
47,5	N-85700
75,5	N-85701
95,5	N-85702
120,5	N-85703

### CONJUNTO TIRA ILUMINACIÓN LEDS

Con sensor de movimiento

descripción	ref.
2 tiras led por hueco	N-85800
1 tira led por hueco	N-85801

# Tiradores

## TIRADORES GRUPO A

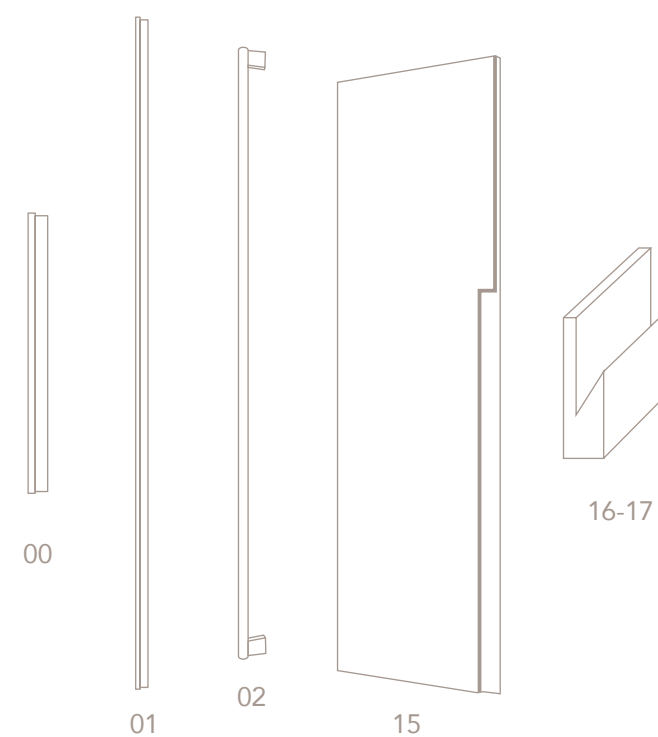

descripción	referencia
00 orsay 20 (lacado)	80955
02 orsay 110 (lacado)	80956
02 barra A	80957
15 fresado	80962
16 tirador uñero hasta 120	80964
17 tirador uñero a partir de 120	80965

## TIRADORES GRUPO B

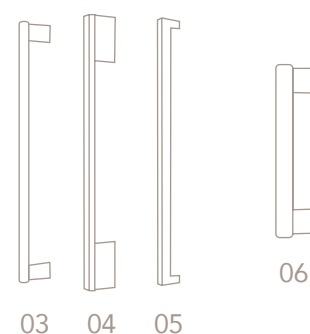

descripción	referencia
03 barra B	80958
04 recto	80959
05 pletina	80960
06 barra C	80961

## TIRADORES GRUPO C

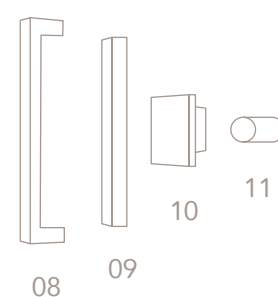

descripción	referencia
08 triangular	20775
09 rectangular	20776
10 plano	20777
11 cilindro	20778

# Cajeados

## Cajeados columna

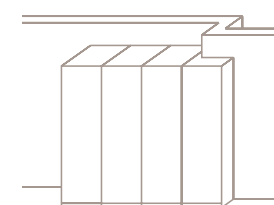

descripción	ref.
encaje lateral	80934

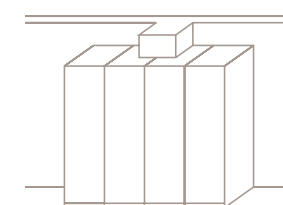

descripción	ref.
encaje central	80935

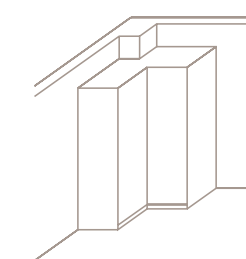

descripción	ref.
encaje rincón	80936

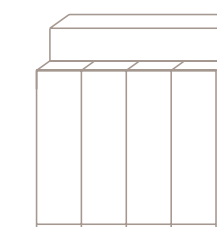

descripción	ref.
encaje jácena	80937

# Tapetas

## 1 canto recto

Precio tapeta M.L. grueso 2

anchos	ref.
de 5	80938
de 5 a 10	80939
de 10 a 20	80940

## 2 cantos rectos

Precio tapeta M.L. grueso 2

anchos	ref.
de 5	80941
de 5 a 10	80942
de 10 a 20	80943

## 1 canto romo

Precio tapeta M.L. grueso 2

anchos	ref.
de 5	80944
de 5 a 10	80945
de 10 a 20	80946

## 2 cantos romos

Precio tapeta M.L. grueso 2

anchos	ref.
de 5	80947
de 5 a 10	80948
de 10 a 20	80949

# Junquillo



descripción	ref.
precio M.L.	80952

# Puerta

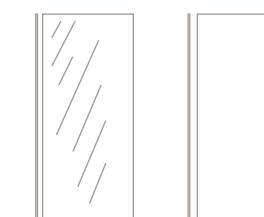

Puertas espejo y madera (incluye las bisagras)

descripción	ref.
espejo m <sup>2</sup>	80953
madera m <sup>2</sup>	80954

# Luna

descripción	ref.
luna espejo 4 mm	80927
luna mate	80930
plata/bronce/gris 4mm	

# Cristal

descripción	ref.
cristal pintado sin templar 4 mm	80933

## Columnas

### COLUMNAS • Fondo 15 cm / grueso 4 cm

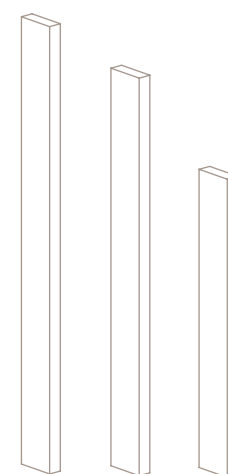

lacado / chapa	
ancho	referencia
180	10000
220	10001
242	10002
272	10003

melamina	
ancho	referencia
180	10013
220	10014
242	10015
272	10016

### COLUMNAS AJUSTE • Fondo 15 cm / grueso 2 cm

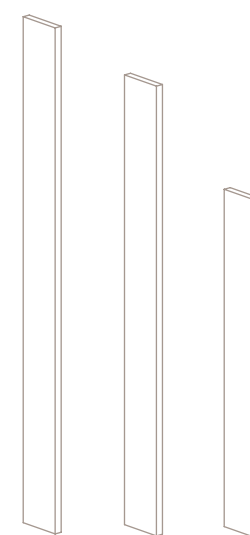

#### NOTA.

Por defecto, cuando queramos encajar un vestidor entre paredes, se descontarán 2 cm por lado, de la medida total del vestidor.

En caso de querer un ajuste más preciso, se utilizarán columnas de ajuste y tapetas entre columnas, de 2 cm.

lacado / chapa	
ancho	referencia
180	10027
220	10028
242	10029
272	10030

melamina	
ancho	referencia
180	10038
220	10039
242	10040
272	10041

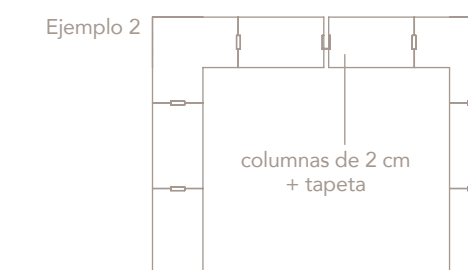
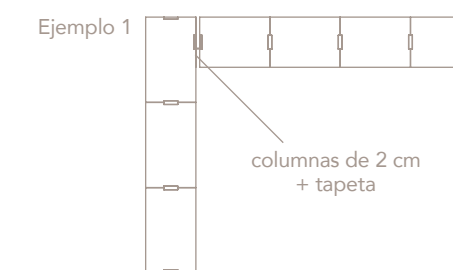

### COLUMNAS RINCÓN • Fondo 2 cm / grueso 2 cm



lacado / chapa	
ancho	referencia
180	10052
220	10053
242	10054
272	10055

melamina	
ancho	referencia
180	10066
220	10067
242	10068
272	10069

# vestidor vista

## Estantes Vista

ESTANTES • Fondo 30 cm / grueso 3 cm

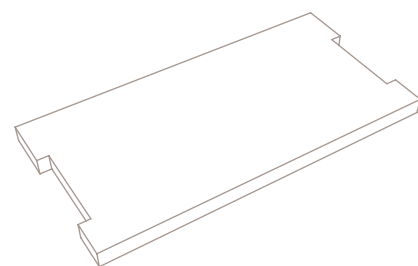

lacado / chapa	
ancho	referencia
34	10100
49	10101
64	10102
79	10103
94	10104
109	10105

melamina	
ancho	referencia
34	10116
49	10117
64	10118
79	10119
94	10120
109	10121

ESTANTES • Fondo 55 cm / grueso 3 cm

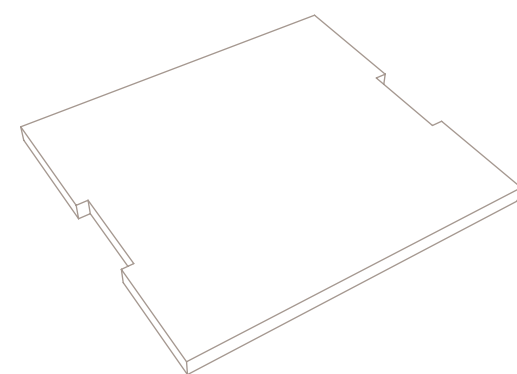

lacado / chapa	
ancho	referencia
34	10132
49	10133
64	10134
79	10135
94	10136
109	10137

melamina	
ancho	referencia
34	10148
49	10149
64	10150
79	10151
94	10152
109	10153

## Estantes Vista

ESTANTES RINCÓN • Fondo 30 cm / grueso 3 cm

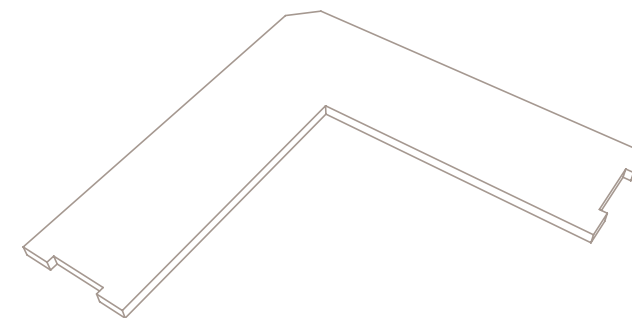

lacado / chapa	
ancho	referencia
104 x 104	10164
114 x 114	10165

melamina	
ancho	referencia
104 x 104	10176
114 x 114	10177

ESTANTES RINCÓN • Fondo 55 cm / grueso 3 cm

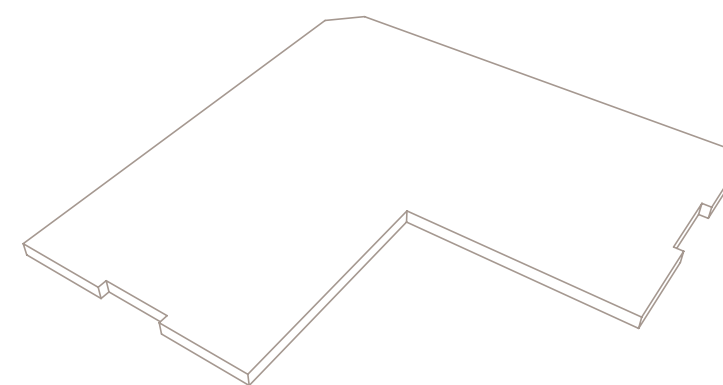

lacado / chapa	
ancho	referencia
104 x 104	10188
114 x 114	10189

melamina	
ancho	referencia
104 x 104	10200
114 x 114	10201

## Paneles vista

PANELES • *alto 242 cm / grueso 1,6 cm*

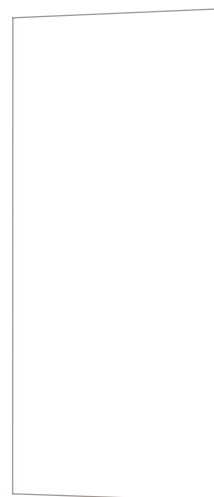

lacado / chapa	
ancho	referencia
34	10260
49	10261
64	10262
79	10263
94	10264
109	10265

melamina	
ancho	referencia
34	10277
49	10278
64	10279
79	10280
94	10281
109	10282

PANELES • *alto 272 cm / grueso 1,6 cm*

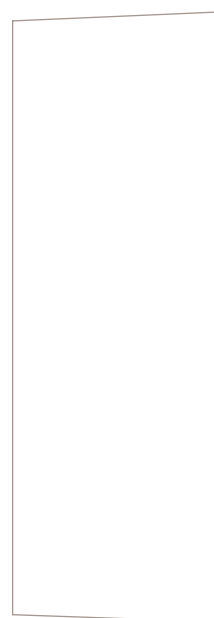

lacado / chapa	
ancho	referencia
34	10300
49	10301
64	10302
79	10303
94	10304
109	10305

melamina	
ancho	referencia
34	10316
49	10317
64	10318
79	10319
94	10320
109	10321

## Cajoneras Vista

CAJONERA 1 CAJÓN • *Fondo 38 cm*

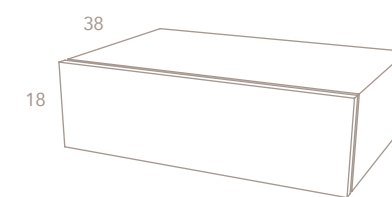

lacado / chapa	
ancho	referencia
30	10550
45	10551
60	10552
75	10553
90	10554
105	10555

melamina	
ancho	referencia
30	10566
45	10567
60	10568
75	10569
90	10570
105	10571

CAJONERA 2 CAJONES • *Fondo 38 cm*

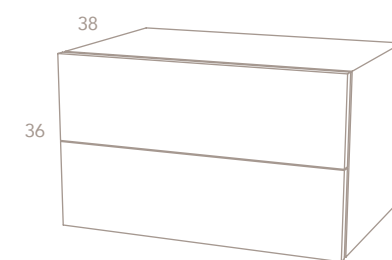

lacado / chapa	
ancho	referencia
30	10582
45	10583
60	10584
75	10585
90	10586
105	10587

melamina	
ancho	referencia
30	10598
45	10599
60	10600
75	10601
90	10602
105	10603

CAJONERA 3 CAJONES • *Fondo 38 cm*

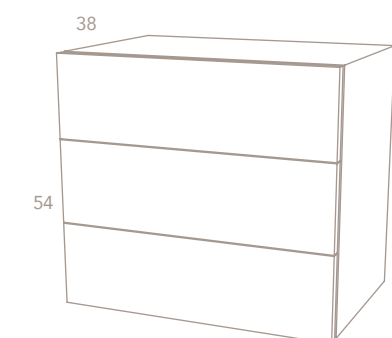

lacado / chapa	
ancho	referencia
30	10614
45	10615
60	10616
75	10617
90	10618
105	10619

melamina	
ancho	referencia
30	10630
45	10631
60	10632
75	10633
90	10634
105	10635

## Cajoneras Vista

### CAJONERA 4 CAJONES • Fondo 38 cm

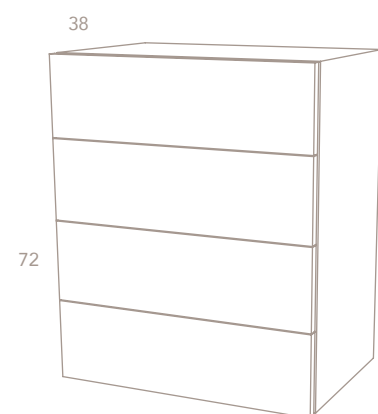

lacado / chapa	
ancho	referencia
30	10645
45	10646
60	10647
75	10648
90	10649
105	10650

melamina	
ancho	referencia
30	10661
45	10662
60	10663
75	10664
90	10665
105	10666

### CAJONERA 5 CAJONES • Fondo 38 cm

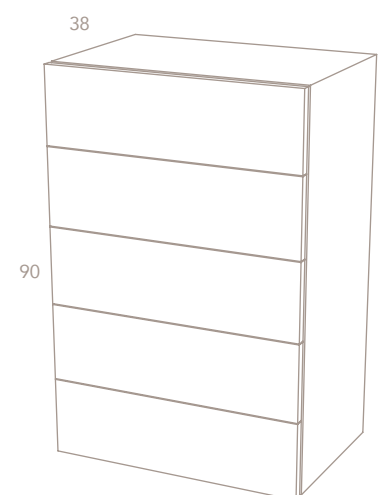

lacado / chapa	
ancho	referencia
30	10677
45	10678
60	10679
75	10680
90	10681
105	10682

melamina	
ancho	referencia
30	10693
45	10694
60	10695
75	10696
90	10697
105	10698

## Cajoneras Vista

### CAJONERA 1 CAJÓN • Fondo 55 cm

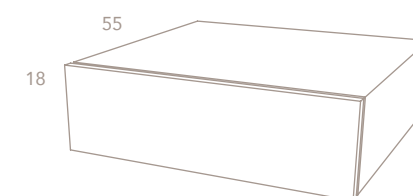

lacado / chapa	
ancho	referencia
30	10711
45	10712
60	10713
75	10714
90	10715
105	10716

melamina	
ancho	referencia
30	10727
45	10728
60	10729
75	10730
90	10731
105	10732

### CAJONERA 2 CAJONES • Fondo 55 cm

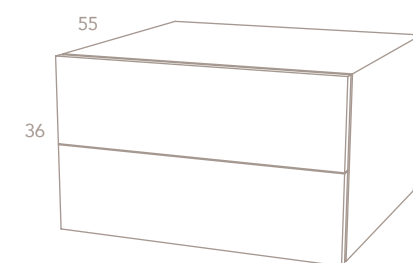

lacado / chapa	
ancho	referencia
30	10743
45	10744
60	10745
75	10746
90	10747
105	10748

melamina	
ancho	referencia
30	10759
45	10760
60	10761
75	10762
90	10763
105	10764

### CAJONERA 3 CAJONES • Fondo 55 cm

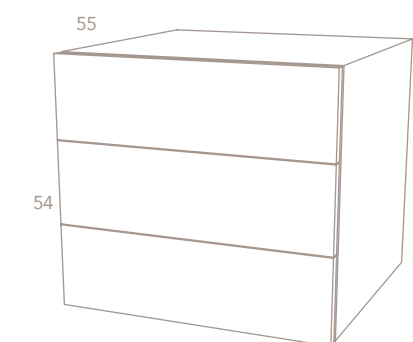

lacado / chapa	
ancho	referencia
30	10775
45	10776
60	10777
75	10778
90	10779
105	10780

melamina	
ancho	referencia
30	10791
45	10792
60	10793
75	10794
90	10795
105	10796



## Cajoneras Vista

CAJONERA 4 CAJONES • Fondo 55 cm

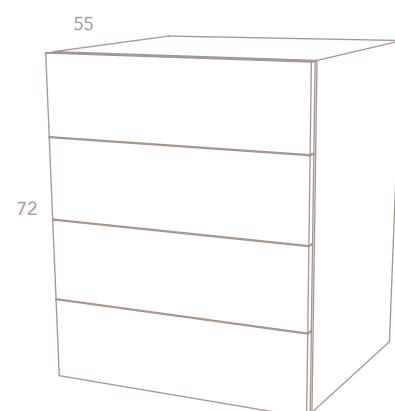

lacado / chapa	
ancho	referencia
30	10807
45	10808
60	10809
75	10810
90	10811
105	10812

melamina	
ancho	referencia
30	10823
45	10824
60	10825
75	10826
90	10827
105	10828

CAJONERA 5 CAJONES • Fondo 55 cm

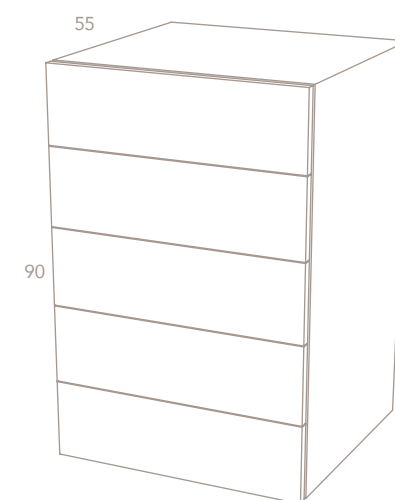

lacado / chapa	
ancho	referencia
30	10839
45	10840
60	10841
75	10842
90	10843
105	10844

melamina	
ancho	referencia
30	10855
45	10856
60	10857
75	10858
90	10859
105	10860

## Módulos zapateros Vista

MÓDULOS ZAPATEROS CON Y SIN ZÓCALO

Fondo 41,5 cm / Módulo 1 puerta

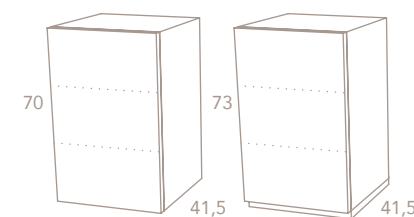

sin zócalo			
lacado / chapa		melamina	
ancho	referencia	ancho	referencia
30	10871	30	10885
45	10872	45	10886
60	10873	60	10887

con zócalo			
lacado / chapa		melamina	
ancho	referencia	ancho	referencia
30	10871 Z	30	10885 Z
45	10872 Z	45	10886 Z
60	10873 Z	60	10887 Z

sin zócalo			
lacado / chapa		melamina	
ancho	referencia	ancho	referencia
30	10898	30	10911
45	10899	45	10912
60	10900	60	10913

con zócalo			
lacado / chapa		melamina	
ancho	referencia	ancho	referencia
30	10898 Z	30	10911 Z
45	10899 Z	45	10912 Z
60	10900 Z	60	10913 Z

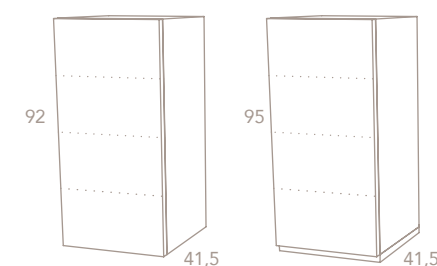

## Módulos zapateros Vista

### MÓDULOS ZAPATEROS CON Y SIN ZÓCALO

Fondo 41,5 cm / Módulo 1 puerta

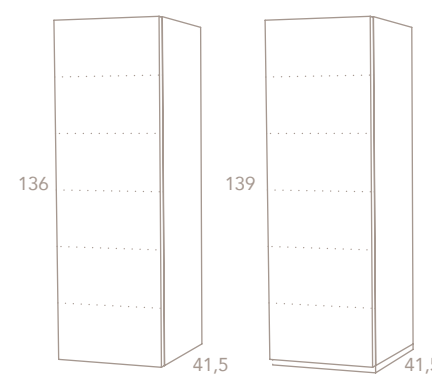
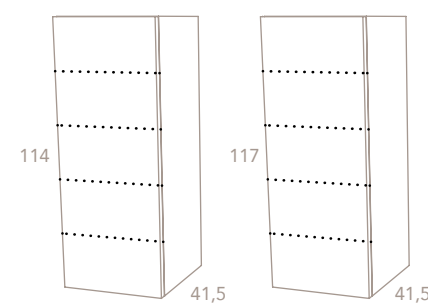

#### sin zócalo

lacado / chapa		melamina	
ancho	referencia	ancho	referencia
30	10924	30	10937
45	10925	45	10938
60	10926	60	10939

#### con zócalo

lacado / chapa		melamina	
ancho	referencia	ancho	referencia
30	10924 Z	30	10937 Z
45	10925 Z	45	10938 Z
60	10926 Z	60	10939 Z

#### sin zócalo

lacado / chapa		melamina	
ancho	referencia	ancho	referencia
30	10950	30	10963
45	10951	45	10964
60	10952	60	10965

#### con zócalo

lacado / chapa		melamina	
ancho	referencia	ancho	referencia
30	10950 Z	30	10963 Z
45	10951 Z	45	10964 Z
60	10952 Z	60	10965 Z

## Módulos zapateros Vista

### MÓDULOS ZAPATEROS CON Y SIN ZÓCALO

Fondo 41,5 cm / Módulo 1 puerta

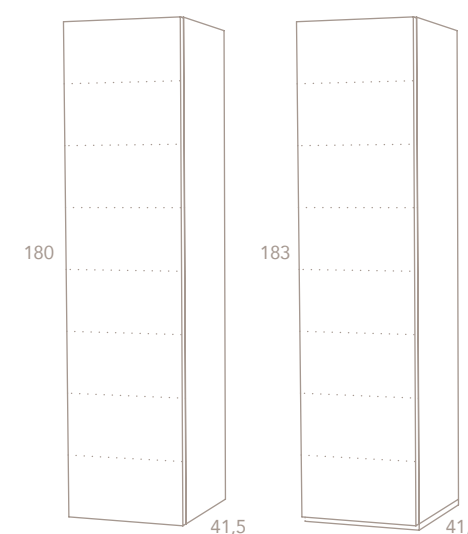
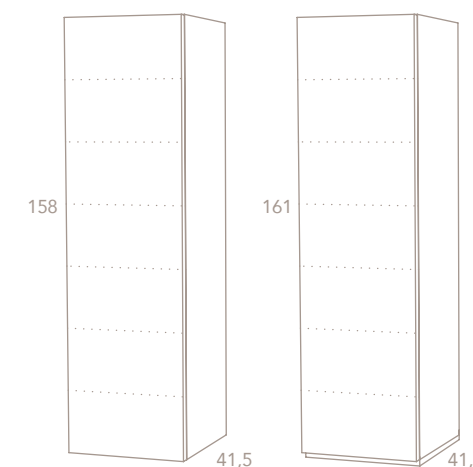

#### sin zócalo

lacado / chapa		melamina	
ancho	referencia	ancho	referencia
30	10976	30	10989
45	10977	45	10990
60	10978	60	10991

#### con zócalo

lacado / chapa		melamina	
ancho	referencia	ancho	referencia
30	10976 Z	30	10989 Z
45	10977 Z	45	10990 Z
60	10978 Z	60	10991 Z

#### sin zócalo

lacado / chapa		melamina	
ancho	referencia	ancho	referencia
30	11000	30	11013
45	11001	45	11014
60	11002	60	11015

#### con zócalo

lacado / chapa		melamina	
ancho	referencia	ancho	referencia
30	11000 Z	30	11013 Z
45	11001 Z	45	11014 Z
60	11002 Z	60	11015 Z

## Módulos zapateros Vista

### MÓDULOS ZAPATEROS CON Y SIN ZÓCALO

Fondo 41,5 cm / Módulo 1 puerta

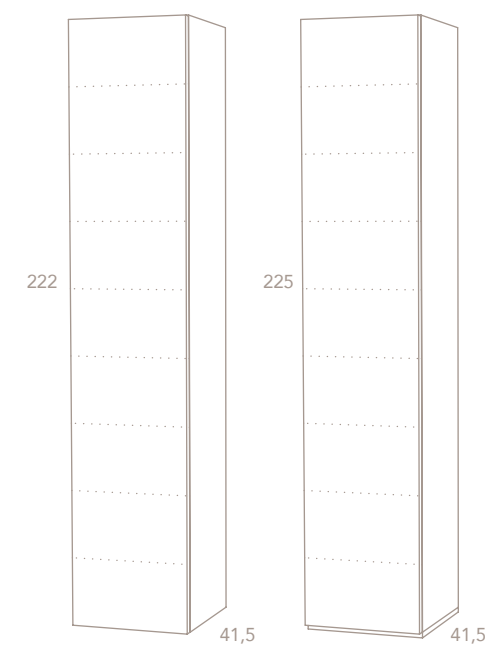
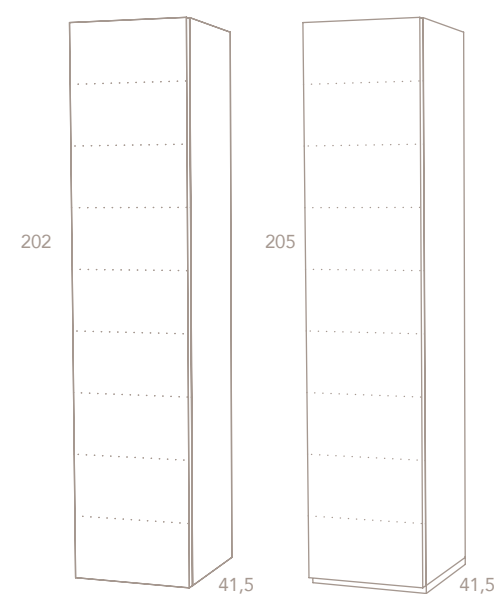

#### sin zócalo

lacado / chapa		melamina	
ancho	referencia	ancho	referencia
30	11026	30	11039
45	11027	45	11040
60	11028	60	11041

#### con zócalo

lacado / chapa		melamina	
ancho	referencia	ancho	referencia
30	11026 Z	30	11039 Z
45	11027 Z	45	11040 Z
60	11028 Z	60	11041 Z

#### sin zócalo

lacado / chapa		melamina	
ancho	referencia	ancho	referencia
30	11052	30	11065
45	11053	45	11066
60	11054	60	11067

#### con zócalo

lacado / chapa		melamina	
ancho	referencia	ancho	referencia
30	11052 Z	30	11065 Z
45	11053 Z	45	11066 Z
60	11054 Z	60	11067 Z

## Módulos zapateros Vista

### MÓDULOS ZAPATEROS CON Y SIN ZÓCALO

Fondo 55 cm / Módulo 1 puerta

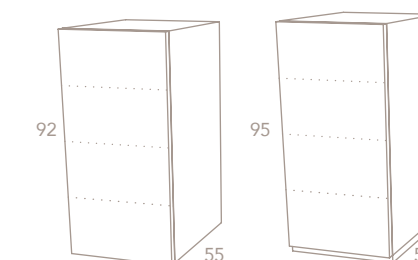
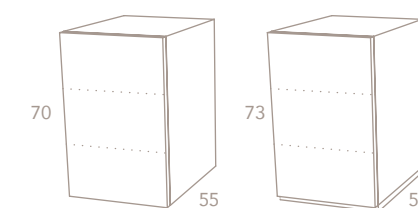

#### sin zócalo

lacado / chapa		melamina	
ancho	referencia	ancho	referencia
30	11100	30	11113
45	11101	45	11114
60	11102	60	11115

#### con zócalo

lacado / chapa		melamina	
ancho	referencia	ancho	referencia
30	11100 Z	30	11113 Z
45	11101 Z	45	11114 Z
60	11102 Z	60	11115 Z

#### sin zócalo

lacado / chapa		melamina	
ancho	referencia	ancho	referencia
30	11126	30	11139
45	11127	45	11140
60	11128	60	11141

#### con zócalo

lacado / chapa		melamina	
ancho	referencia	ancho	referencia
30	11126 Z	30	11139 Z
45	11127 Z	45	11140 Z
60	11128 Z	60	11141 Z

## Módulos zapateros Vista

### MÓDULOS ZAPATEROS CON Y SIN ZÓCALO

Fondo 55 cm / Módulo 1 puerta

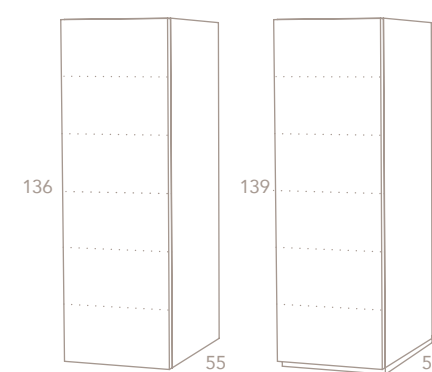
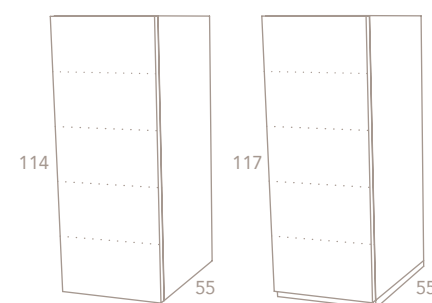

#### sin zócalo

lacado / chapa		melamina	
ancho	referencia	ancho	referencia
30	11152	30	11165
45	11153	45	11166
60	11154	60	11167

#### con zócalo

lacado / chapa		melamina	
ancho	referencia	ancho	referencia
30	11152 Z	30	11165 Z
45	11153 Z	45	11166 Z
60	11154 Z	60	11167 Z

#### sin zócalo

lacado / chapa		melamina	
ancho	referencia	ancho	referencia
30	11178	30	11191
45	11179	45	11192
60	11180	60	11193

#### con zócalo

lacado / chapa		melamina	
ancho	referencia	ancho	referencia
30	11178 Z	30	11191 Z
45	11179 Z	45	11192 Z
60	11180 Z	60	11193 Z

## Módulos zapateros Vista

### MÓDULOS ZAPATEROS CON Y SIN ZÓCALO

Fondo 55 cm / Módulo 1 puerta

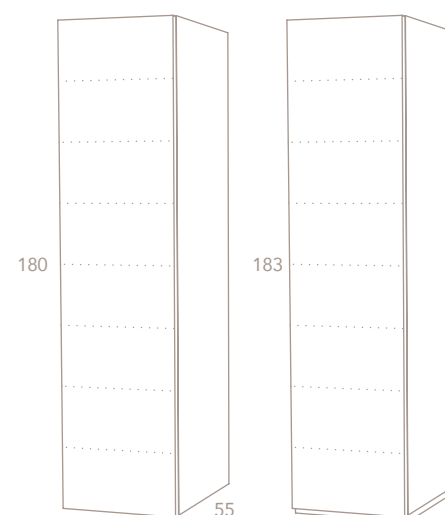
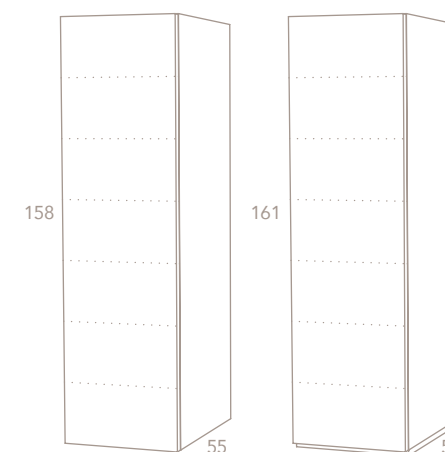

#### sin zócalo

lacado / chapa		melamina	
ancho	referencia	ancho	referencia
30	11204	30	11217
45	11205	45	11218
60	11206	60	11219

#### con zócalo

lacado / chapa		melamina	
ancho	referencia	ancho	referencia
30	11204 Z	30	11217 Z
45	11205 Z	45	11218 Z
60	11206 Z	60	11219 Z

#### sin zócalo

lacado / chapa		melamina	
ancho	referencia	ancho	referencia
30	11230	30	11243
45	11231	45	11244
60	11232	60	11245

#### con zócalo

lacado / chapa		melamina	
ancho	referencia	ancho	referencia
30	11230 Z	30	11243 Z
45	11231 Z	45	11244 Z
60	11232 Z	60	11245 Z

## Módulos zapateros Vista

### MÓDULOS ZAPATEROS CON Y SIN ZÓCALO

Fondo 55 cm / Módulo 1 puerta

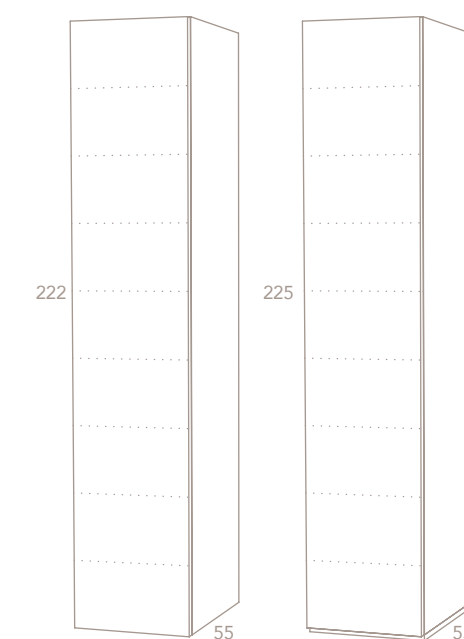
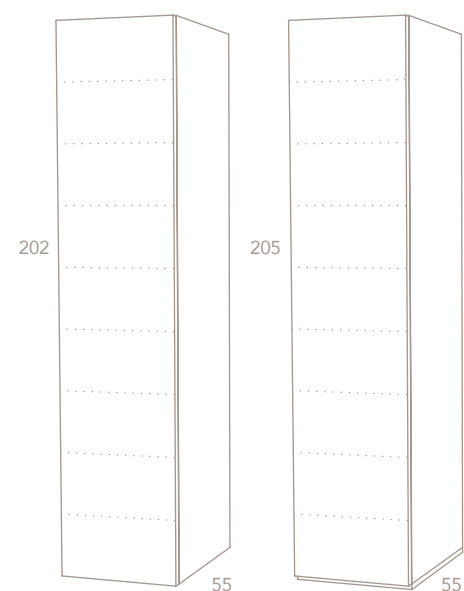

#### sin zócalo

lacado / chapa		melamina	
ancho	referencia	ancho	referencia
30	11256	30	11269
45	11257	45	11270
60	11258	60	11271

#### con zócalo

lacado / chapa		melamina	
ancho	referencia	ancho	referencia
30	11256 Z	30	11269 Z
45	11257 Z	45	11270 Z
60	11258 Z	60	11271 Z

#### sin zócalo

lacado / chapa		melamina	
ancho	referencia	ancho	referencia
30	11282	30	11295
45	11283	45	11296
60	11284	60	11297

#### con zócalo

lacado / chapa		melamina	
ancho	referencia	ancho	referencia
30	11282 Z	30	11295 Z
45	11283 Z	45	11296 Z
60	11284 Z	60	11297 Z

## Estantes interiores zapatero Vista

ESTANTES INTERIORES • Fondo 35 cm / Grueso 1 cm

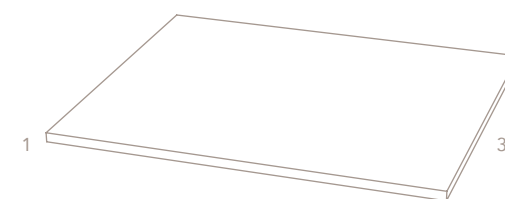

lacado / chapa	
ancho	referencia
26	11358
41	11359
56	11360

melamina	
ancho	referencia
26	11371
41	11372
56	11373

ESTANTES INTERIORES • Fondo 48 cm / Grueso 1 cm

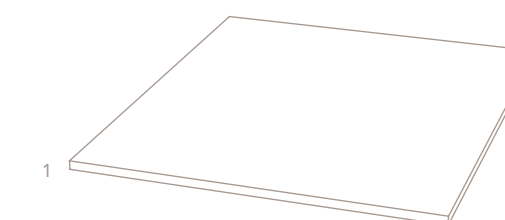

lacado / chapa	
ancho	referencia
26	11384
41	11385
56	11386

melamina	
ancho	referencia
26	11397
41	11398
56	11399

puertas correderas de  
**aluminio**  
**vista**  
 cierre entre paredes

## Puertas correderas de aluminio Vista cierre entre paredes

### INFORMACIÓN TÉCNICA MONTAJE

#### CARACTERÍSTICAS

- Puertas correderas de paso para vestidores, sin guía inferior en suelo.
- Las puertas corren entre sí, entre las paredes, sobre una guía superior doble.
- Longitud y altura siempre se cuentan centímetro a centímetro, hasta una altura máxima de 272 cm.

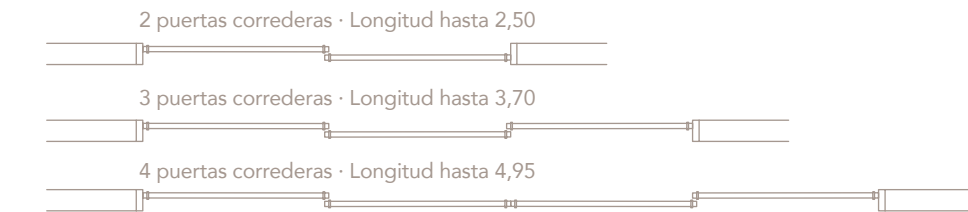

#### TIPOS DE PUERTAS

Las puertas van siempre con perfilera de Aluminio, bien acabadas a dos caras y en color aluminio o cualquier color de nuestro muestrario. Llevan el tirador incorporado de arriba/abajo, formando parte de la perfilera. Las puertas se pueden mandar desmontadas.

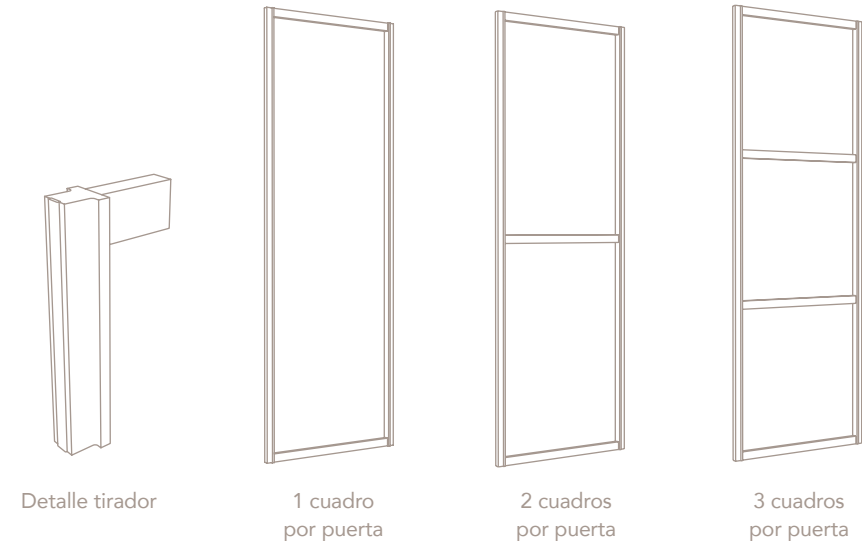

#### EN EL PRECIO INCLUIMOS:

Las Puertas, el mecanismo corredero, 1 regrueso superior de 9 cm de ancho por 2 cm de grueso con la guía doble superior, 2 tapetas superiores y 2 pies verticales de 9 cm de ancho por 2 cm de grueso.

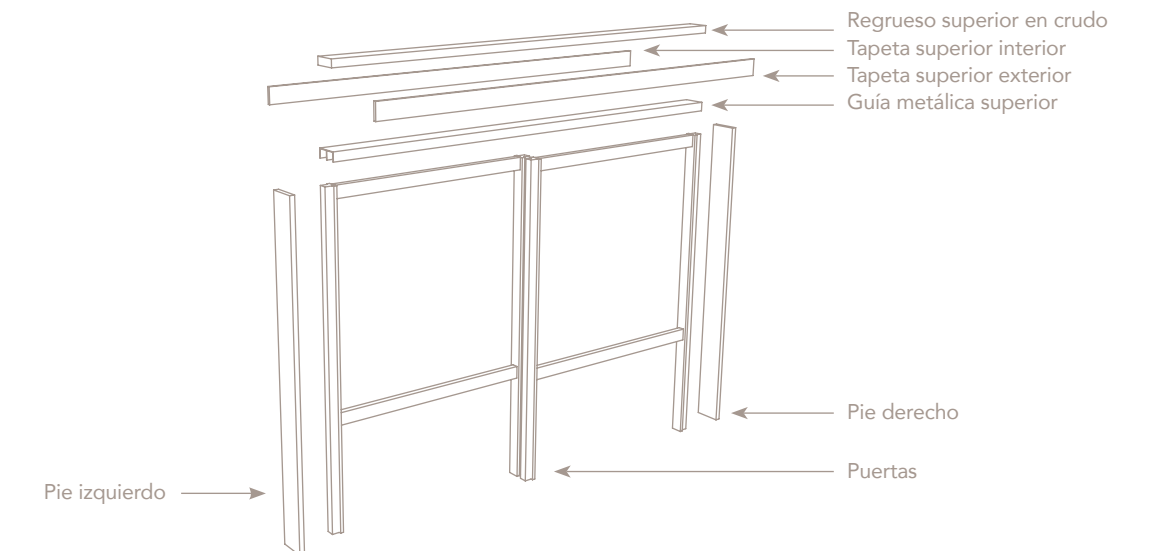
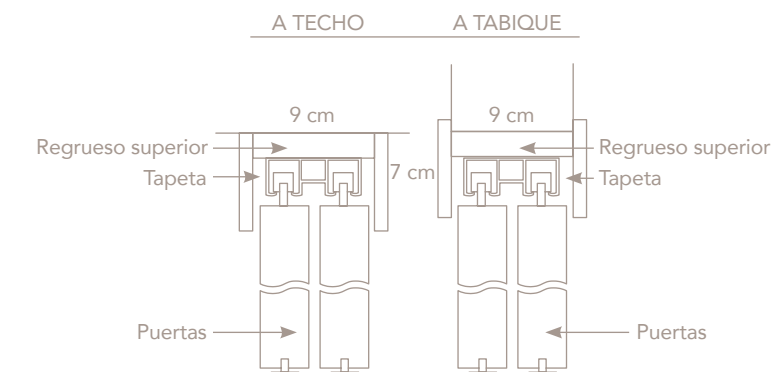

## Puertas correderas de aluminio Vista cierre entre paredes

### INFORMACIÓN TÉCNICA MONTAJE

#### IMPORTANTE

La empresa no se hace responsable de los problemas de resistencia que pudieran surgir en el techo.

#### EN EL PRECIO NO SE INCLUYE:

Las tapetas laterales para rematar el frente.  
Precio, consultar página 39 de la Tarifa.

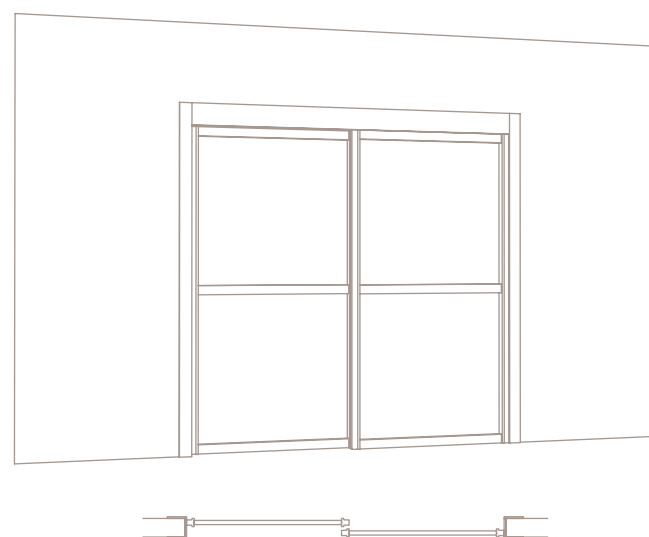
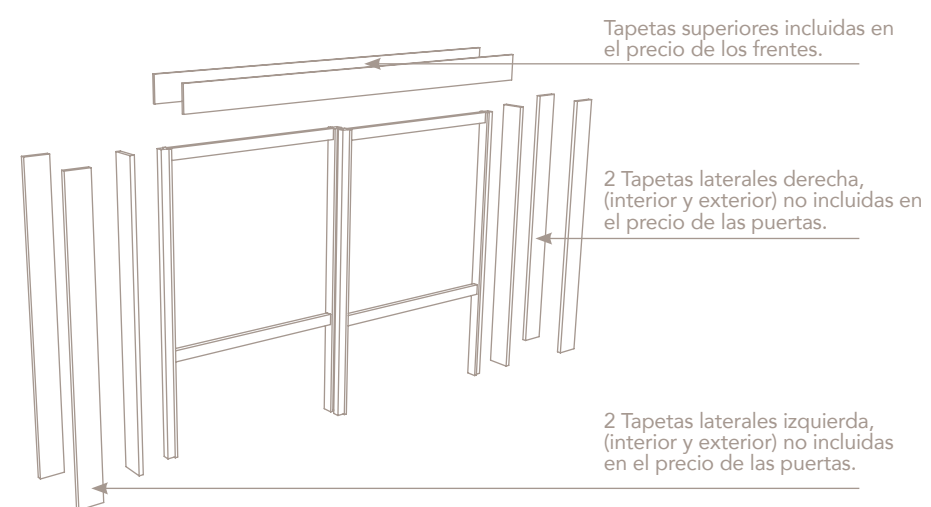

**NOTA.** En cada pedido es necesario indicar la altura y la anchura del hueco de luz de paso.

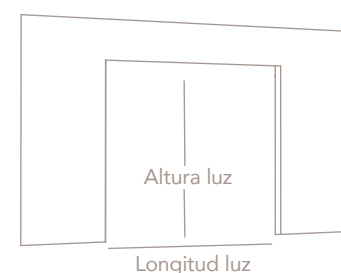

## Puertas correderas de aluminio Vista, cierre entre paredes

### 2 PUERTAS DE PASO ENTRE PAREDES

**NOTA.**  
La Perfilería de aluminio siempre va color aluminio, sino fuese así, especificar color y sumar 75 puntos más por puerta.



Ancho hasta 150	1 Cuadro por puerta		2 Cuadros por puerta		3 Cuadros por puerta	
Paneles Puertas	alto	referencia	alto	referencia	alto	referencia
Chapa sintética	242	11750	242	11751	242	11752
	272	11753	272	11754	272	11755
Cristal laminado transparente	242	11756	242	11757	242	11758
	272	11759	272	11760	272	11761
Cristal pintado	242	11762	242	11763	242	11764
	272	11765	272	11766	272	11767
Chapa / Lacado	242	11768	242	11769	242	11770
	272	11771	272	11772	272	11773

Ancho hasta 200	1 Cuadro por puerta		2 Cuadros por puerta		3 Cuadros por puerta	
Paneles Puertas	alto	referencia	alto	referencia	alto	referencia
Chapa sintética	242	11774	242	11775	242	11776
	272	11777	272	11778	272	11779
Cristal laminado transparente	242	11780	242	11781	242	11782
	272	11783	272	11784	272	11785
Cristal pintado	242	11786	242	11787	242	11788
	272	11789	272	11790	272	11791
Chapa / Lacado	242	11792	242	11793	242	11794
	272	11795	272	11796	272	11797

Ancho hasta 250	1 Cuadro por puerta		2 Cuadros por puerta		3 Cuadros por puerta	
Paneles Puertas	alto	referencia	alto	referencia	alto	referencia
Chapa sintética	242	11798	242	11799	242	11800
	272	11801	272	11802	272	11803
Cristal laminado transparente	242	11804	242	11805	242	11806
	272	11807	272	11808	272	11809
Cristal pintado	242	11810	242	11811	242	11812
	272	11813	272	11814	272	11815
Chapa / Lacado	242	11816	242	11817	242	11818
	272	11819	272	11820	272	11821

## Puertas correderas de aluminio Vista, cierre entre paredes

### 3 PUERTAS DE PASO ENTRE PAREDES

**NOTA.**  
La Perfilería de aluminio siempre va color aluminio, sino fuese así, especificar color y sumar 75 puntos más por puerta.

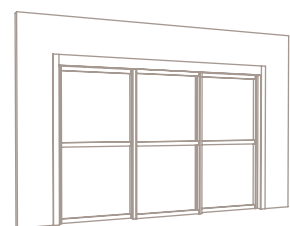

Ancho hasta 220	1 Cuadro por puerta		2 Cuadros por puerta		3 Cuadros por puerta	
Paneles Puertas	<b>alto</b>	<b>referencia</b>	<b>alto</b>	<b>referencia</b>	<b>alto</b>	<b>referencia</b>
Chapa sintética	242	11922	242	11923	242	11924
	272	11925	272	11926	272	11927
Cristal laminado transparente	242	11928	242	11929	242	11930
	272	11931	272	11932	272	11933
Cristal pintado	242	11934	242	11935	242	11936
	272	11937	272	11938	272	11939
Chapa / Lacado	242	11940	242	11941	242	11942
	272	11943	272	11944	272	11945

Ancho hasta 295	1 Cuadro por puerta		2 Cuadros por puerta		3 Cuadros por puerta	
Paneles Puertas	<b>alto</b>	<b>referencia</b>	<b>alto</b>	<b>referencia</b>	<b>alto</b>	<b>referencia</b>
Chapa sintética	242	11946	242	11947	242	11948
	272	11949	272	11950	272	11951
Cristal laminado transparente	242	11952	242	11953	242	11954
	272	11955	272	11956	272	11957
Cristal pintado	242	11958	242	11959	242	11960
	272	11961	272	11962	272	11963
Chapa / Lacado	242	11964	242	11965	242	11966
	272	11967	272	11968	272	11969

Ancho hasta 370	1 Cuadro por puerta		2 Cuadros por puerta		3 Cuadros por puerta	
Paneles Puertas	<b>alto</b>	<b>referencia</b>	<b>alto</b>	<b>referencia</b>	<b>alto</b>	<b>referencia</b>
Chapa sintética	242	11970	242	11971	242	11972
	272	11973	272	11974	272	11975
Cristal laminado transparente	242	11976	242	11977	242	11978
	272	11979	272	11980	272	11981
Cristal pintado	242	11982	242	11983	242	11984
	272	11985	272	11986	272	11987
Chapa / Lacado	242	11988	242	11989	242	11990
	272	11991	272	11992	272	11993

## Puertas correderas de aluminio Vista, cierre entre paredes

### 4 PUERTAS DE PASO ENTRE PAREDES

**NOTA.**  
La Perfilería de aluminio siempre va color aluminio, sino fuese así, especificar color y sumar 75 puntos más por puerta.

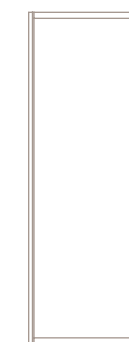
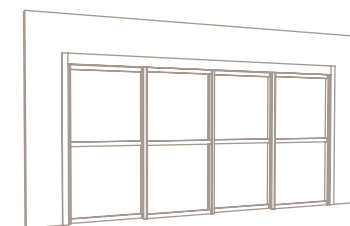

Ancho hasta 295	1 Cuadro por puerta		2 Cuadros por puerta		3 Cuadros por puerta	
Paneles Puertas	<b>alto</b>	<b>referencia</b>	<b>alto</b>	<b>referencia</b>	<b>alto</b>	<b>referencia</b>
Chapa sintética	242	12100	242	12101	242	12102
	272	12103	272	12104	272	12105
Cristal laminado transparente	242	12106	242	12107	242	12108
	272	12109	272	12110	272	12111
Cristal pintado	242	12112	242	12113	242	12114
	272	12115	272	12116	272	12117
Chapa / Lacado	242	12118	242	12119	242	12120
	272	12121	272	12122	272	12123

Ancho hasta 395	1 Cuadro por puerta		2 Cuadros por puerta		3 Cuadros por puerta	
Paneles Puertas	<b>alto</b>	<b>referencia</b>	<b>alto</b>	<b>referencia</b>	<b>alto</b>	<b>referencia</b>
Chapa sintética	242	12124	242	12125	242	12126
	272	12127	272	12128	272	12129
Cristal laminado transparente	242	12130	242	12131	242	12132
	272	12133	272	12134	272	12135
Cristal pintado	242	12136	242	12137	242	12138
	272	12139	272	12140	272	12141
Chapa / Lacado	242	12142	242	12143	242	12144
	272	12145	272	12146	272	12147

Ancho hasta 495	1 Cuadro por puerta		2 Cuadros por puerta		3 Cuadros por puerta	
Paneles Puertas	<b>alto</b>	<b>referencia</b>	<b>alto</b>	<b>referencia</b>	<b>alto</b>	<b>referencia</b>
Chapa sintética	242	12148	242	12149	242	12150
	272	12151	272	12152	272	12153
Cristal laminado transparente	242	12154	242	12155	242	12156
	272	12157	272	12158	272	12159
Cristal pintado	242	12160	242	12161	242	12162
	272	12163	272	12164	272	12165
Chapa / Lacado	242	12166	242	12167	242	12168
	272	12169	272	12170	272	12171



## Puertas correderas de aluminio Vista cierre delante de paredes

### INFORMACIÓN TÉCNICA MONTAJE

#### CARACTERÍSTICAS

- Puertas correderas de paso para vestidores, sin guía inferior en suelo.
- Las puertas corren por delante de las paredes, por una guía superior simple.
- Las puertas montarán 3 cm por cada lado sobre las paredes si no se indica la longitud de las mismas.



La frentecilla sobresale de la pared 5,5 cms. El tirador de la puerta queda separado de la pared 1 cm

#### TIPOS DE PUERTAS

Las puertas van siempre con perfilera de Aluminio, bien acabadas a dos caras y en color aluminio o cualquier color de nuestro muestrario. Llevan el tirador incorporado de arriba/abajo, formando parte de la perfilera. Las puertas se pueden mandar desmontadas.

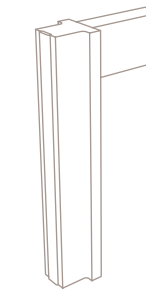

Detalle tirador

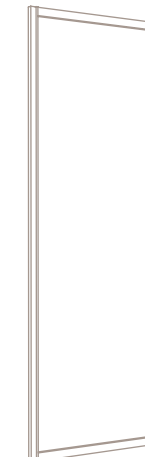

1 cuadro por puerta

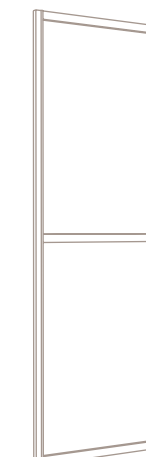

2 cuadros por puerta

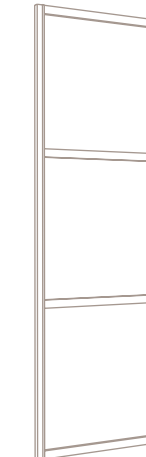

3 cuadros por puerta

#### NOTA.

En cada pedido es necesario detallar: La longitud/altura mínima de hueco y longitud de la frentecilla. La medida de la pared encima del hueco, imprescindible que tenga mínimo 9 cm.

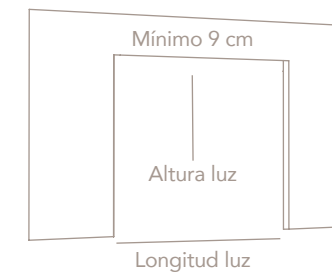

puertas correderas de  
**aluminio**  
**vista**  
 cierre delante de paredes

# Puertas correderas de aluminio Vista cierre delante de paredes

## INFORMACIÓN TÉCNICA MONTAJE

### EN EL PRECIO INCLUIMOS:

Las Puertas, el mecanismo corredero, la frentecilla superior de aluminio de 8 cm de altura y la guía superior. Si no se indica la longitud de la frentecilla superior, esta se considerará de medida el doble de la puerta más 6 centímetros.

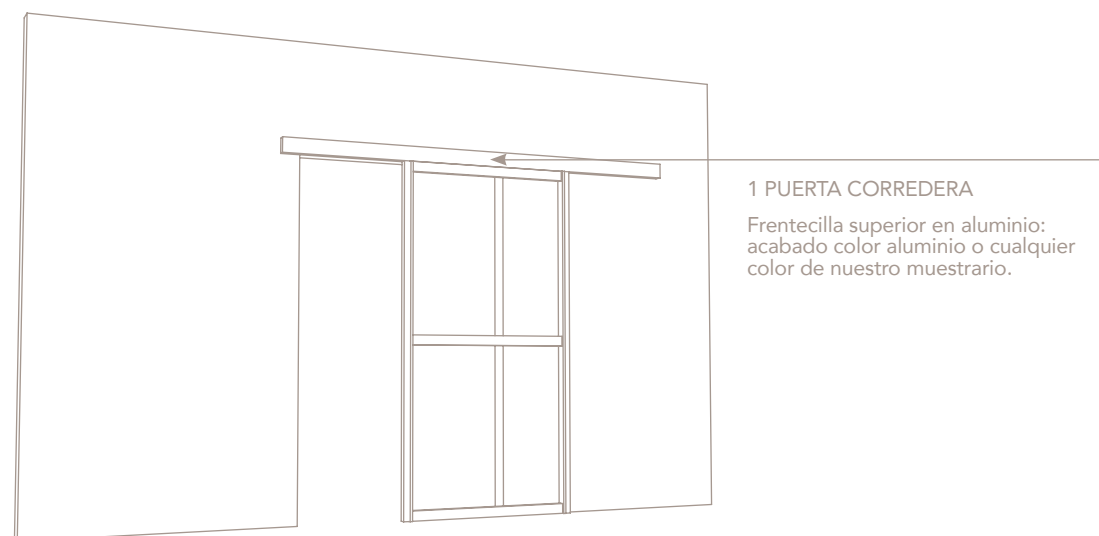

**1 PUERTA CORREDERA**  
Frentecilla superior en aluminio: acabado color aluminio o cualquier color de nuestro muestrario.

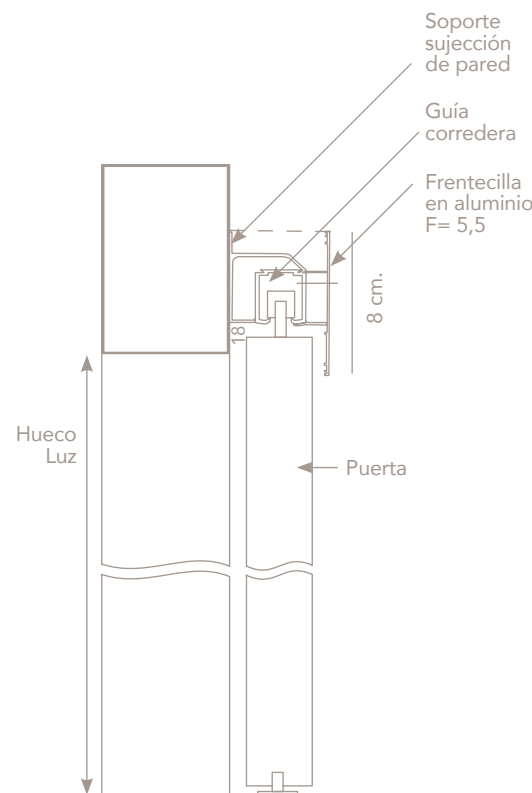

El tirador de la puerta queda separado de la pared 1 cm, si el rodapie tiene más medida, indicarlo para poner un reguero detrás de los soportes a pared y hacer el canto de la frentecilla de más fondo, en este caso incrementar:

40 PUNTOS para los frentes de 1 puerta  
80 PUNTOS para los frentes de 2 puertas

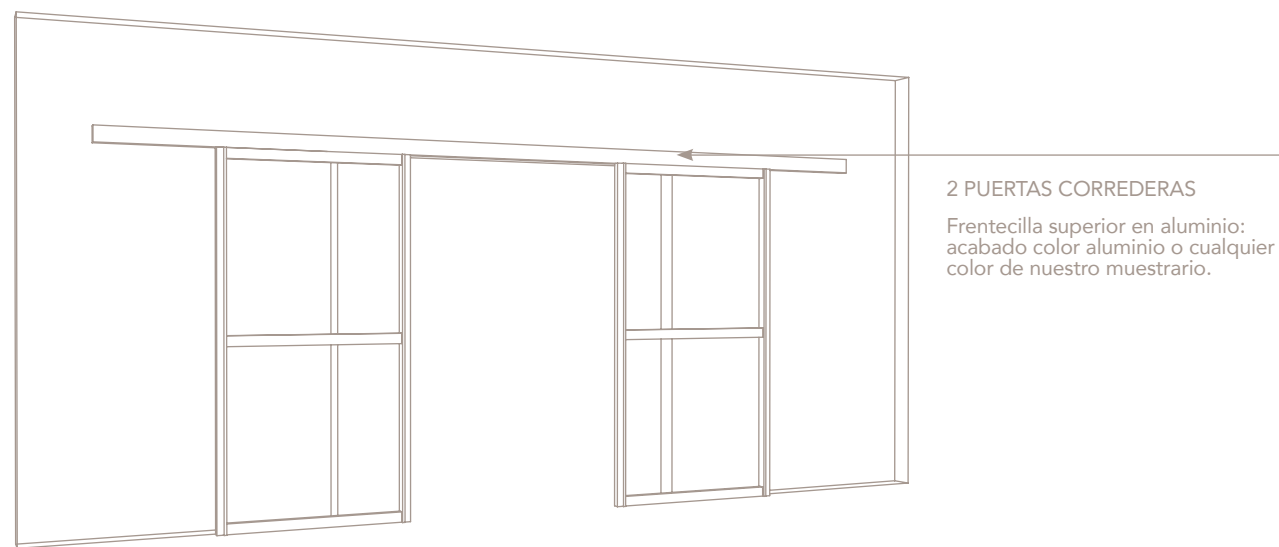

**2 PUERTAS CORREDERAS**  
Frentecilla superior en aluminio: acabado color aluminio o cualquier color de nuestro muestrario.

# Puertas correderas de aluminio Vista cierre delante de paredes

## 1 PUERTA DE PASO DELANTE DE PARED

**NOTA.**  
La Perfilería de aluminio siempre va color aluminio, sino fuese así, especificar color y sumar 75 puntos más por puerta.

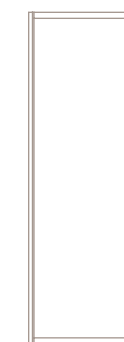
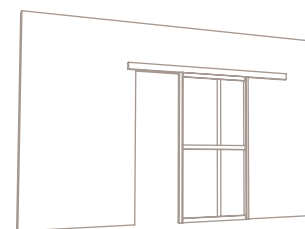

Hueco luz máximo 69 cm PUERTA HASTA 75 cm	1 Cuadro por puerta		2 Cuadros por puerta		3 Cuadros por puerta	
Paneles Puertas	alto	referencia	alto	referencia	alto	referencia
Chapa sintética	242	12300	242	12301	242	12302
	272	12303	272	12304	272	12305
Cristal laminado transparente	242	12306	242	12307	242	12308
	272	12309	272	12310	272	12311
Cristal pintado	242	12312	242	12313	242	12314
	272	12315	272	12316	272	12317
Chapa / Lacado	242	12318	242	12319	242	12320
	272	12321	272	12322	272	12323

Hueco luz máximo 94 cm PUERTA HASTA 100 cm	1 Cuadro por puerta		2 Cuadros por puerta		3 Cuadros por puerta	
Paneles Puertas	alto	referencia	alto	referencia	alto	referencia
Chapa sintética	242	12324	242	12325	242	12326
	272	12327	272	12328	272	12329
Cristal laminado transparente	242	12330	242	12331	242	12332
	272	12333	272	12334	272	12335
Cristal pintado	242	12336	242	12337	242	12338
	272	12339	272	12340	272	12341
Chapa / Lacado	242	12342	242	12343	242	12344
	272	12345	272	12346	272	12347

Hueco luz máximo 119 cm PUERTA HASTA 125 cm	1 Cuadro por puerta		2 Cuadros por puerta		3 Cuadros por puerta	
Paneles Puertas	alto	referencia	alto	referencia	alto	referencia
Chapa sintética	242	12348	242	12349	242	12350
	272	12351	272	12352	272	12353
Cristal laminado transparente	242	12354	242	12355	242	12356
	272	12357	272	12358	272	12359
Cristal pintado	242	12360	242	12361	242	12362
	272	12363	272	12364	272	12365
Chapa / Lacado	242	12366	242	12367	242	12368
	272	12369	272	12370	272	12371

## Puertas correderas de aluminio Vista cierre delante de paredes

### 2 PUERTAS DE PASO DELANTE DE PARED

**NOTA.**  
La Perfilería de aluminio siempre va color aluminio, sino fuese así, especificar color y sumar 75 puntos más por puerta.



Hueco luz máximo 144 cm PUERTA HASTA 75 cm	1 Cuadro por puerta		2 Cuadros por puerta		3 Cuadros por puerta	
Paneles Puertas	alto	referencia	alto	referencia	alto	referencia
Chapa sintética	242	12470	242	12471	242	12472
	272	12473	272	12474	272	12475
Cristal laminado transparente	242	12476	242	12477	242	12478
	272	12479	272	12480	272	12481
Cristal pintado	242	12482	242	12483	242	12484
	272	12485	272	12486	272	12487
Chapa / Lacado	242	12488	242	12489	242	12490
	272	12491	272	12492	272	12493

Hueco luz máximo 194 cm PUERTA HASTA 100 cm	1 Cuadro por puerta		2 Cuadros por puerta		3 Cuadros por puerta	
Paneles Puertas	alto	referencia	alto	referencia	alto	referencia
Chapa sintética	242	12494	242	12495	242	12496
	272	12497	272	12498	272	12499
Cristal laminado transparente	242	12500	242	12501	242	12502
	272	12503	272	12504	272	12505
Cristal pintado	242	12506	242	12507	242	12508
	272	12509	272	12510	272	12511
Chapa / Lacado	242	12512	242	12513	242	12514
	272	12515	272	12516	272	12517

Hueco luz máximo 244 cm PUERTA HASTA 125 cm	1 Cuadro por puerta		2 Cuadros por puerta		3 Cuadros por puerta	
Paneles Puertas	alto	referencia	alto	referencia	alto	referencia
Chapa sintética	242	12518	242	12519	242	12520
	272	12521	272	12522	272	12523
Cristal laminado transparente	242	12524	242	12525	242	12526
	272	12527	272	12528	272	12529
Cristal pintado	242	12530	242	12531	242	12532
	272	12533	272	12534	272	12535
Chapa / Lacado	242	12536	242	12537	242	12538
	272	12539	272	12540	272	12541

## Información general

- Medidas especiales consultar a fábrica.
- Lacados en cualquier color de la carta RAL en mate, con un incremento del precio fijo de 180 puntos fijos independientemente de las piezas a lacar.

### Se fabrican los siguientes acabados:

#### Chapas:

Roble Ceniza  
Roble In  
Roble Lava  
Roble Natural  
Roble Vulcano  
Roble Rustik *(Incremento 10%)*  
Nogal  
Nogal Dark  
Nogal Perú  
Nogal Antik  
Fumé

#### Lacados:

Blanco  
Crudo  
Gris  
Piedra  
Visón  
Cantera  
Cielo  
Turquesa  
Ágata  
Mostaza  
Oliva  
Musgo  
Trigo  
Aranja  
Boston

*(Lacado brillo incremento del 10%)*

#### Cristales pintados:

Blanco  
Crudo  
Gris  
Piedra  
Visón  
Cantera  
Cielo  
Turquesa  
Ágata  
Mostaza  
Oliva  
Musgo  
Trigo  
Aranja  
Boston

#### Chapas sintéticas para vestidores:

Soho  
Enzo  
AC  
Nex  
Artic  
Blanco poro

### Formas de pago

- Contado 5% descuento en un plazo máximo de 10 días fecha factura.
- Giro a 30 días fecha factura 3% descuento.
- Transcurrido este plazo de tiempo el descuento quedará anulado.
- Las entregas cuyo importe sea inferior a 250 € se entregarán a portes debidos.
- Estos precios serán incrementados con el I.V.A vigente.

### Créditos

- Diseño de producto.** Toni Felip y Lluís Codina  
**Fabricación muebles.** Besform  
**Diseño gráfico.** Irene Lahoz y Lluís Codina

En los acabados en madera deben aceptarse ligeras variaciones de tono, propias de las chapas naturales utilizadas. La empresa se reserva el derecho a efectuar modificaciones estéticas y técnicas sin previo aviso en cualquiera de los elementos de esta tarifa.



